

LARSA4D

Section Composer Manual



LARSA Section Composer Manual

A manual for

LARSA 4D
Finite Element Analysis and Design Software

Last Revised February 16, 2023

Copyright (C) 2001-2022 LARSA, Inc. All rights reserved. Information in this document is subject to change without notice and does not represent a commitment on the part of LARSA, Inc. The software described in this document is furnished under a license or nondisclosure agreement. No part of the documentation may be reproduced or transmitted in any form or by any means, electronic or mechanical including photocopying, recording, or information storage or retrieval systems, for any purpose without the express written permission of LARSA, Inc.

Table of Contents

Introduction	5
About LARSA Section Composer	5
Overview	7
Sections, Shapes, and Parameters	7
Composite Sections	9
Screen Overview	10
Section Axes	10
Creating a Section	13
Starting Up	13
Adding Shapes	14
Editing Shape Size and Position	17
Align and Snap	19
Other Shape Tools	21
Stress Recovery Points	21
Calculate Section Properties	22
Other Section Tools	22
Using the Section in LARSA 4D	22
Section Computations	25
Section Properties	25
Torsion Constant	26
Shear Area Factors	26
Free Shapes, Cutouts, and Composite Shapes	27
Drawing the Outer Rectangle	27
Drawing the Cutout	29
Starting a Section Section	30
Composite Shapes	31
Parameterizing the Section	33
Parameters and Formulas	35
Parameterizing the Tube Section	35
Parameter Scope	37
Formula Language	38
Shape Templates	39
Reinforcement Bars	41
Member Reference Line and Local Coordinate System	45
Reference Coordinate Systems	46
Positioning the Section	47
Local Coordinate System	48

Nonprismatic Variation	51
Starting an Example	51
The x Variable	51
Formula Helper	53
Positioning the Centroid	54
Multi-Member Spans	56
Analysis of nonprismatic sections	58
Composite Material Sections	59
Composite Construction Sections	61
Construction Sequence	61
Section Analysis	63
Ultimate Strength Check	63
Moment Curvature Analysis	63
Moment Curvature and Yield Surface	63
Glossary	65

Introduction

About LARSA 4D

LARSA 4D is an advanced multipurpose 3D structural analysis package featuring a powerful graphical user interface and an analysis engine with unmatched analytical features including influence line and surface based live load analysis, staged construction analysis, time-dependent material properties and segmental construction analysis, hysteretic and seismic element and seismic analysis, and progressive collapse.

The LARSA structural analysis engine has been in commercial use for over 25 years. During this time LARSA has become the most trusted software of its kind for segmental, cable-stayed, suspension, steel girder and other bridge forms, as well as other structures requiring advanced staged construction analysis, geometric and material nonlinearity, or complex three-dimensional geometry. With short-span pedestrian to major long-span crossing completed in eight countries and hundreds of cities, LARSA is recognized by leading engineers as the premier software for the design and analysis of today's most iconic structures. We have come a long way since LARSA was first available on VAX super-mini computer decades ago.

LARSA, Inc. has always been an industry leader. LARSA was the first offer an individual PC-based DOS structural analysis package with geometric and material nonlinearity analysis in 1986. In 1994, LARSA took the early next step to Microsoft Windows with a point-and-click graphical user interface and two years later was the first off elastic/perfectly plastic pushover analysis. Today, LARSA's flagship LARSA 4D software products continue to lead the field of bridge software with robust staged construction integrated with nonlinear analysis, influence-surface based live loading, and other complex design needs such as for high-speed rail bridges. Complemented with unique and innovative client support systems, LARSA 4D makes engineers feel comfortable as our developers and support personnel work closely with each client to develop the tools clients need to make their work more efficient and effective.

If you have any questions completing this training manual, you are welcome to contact LARSA's Support Team at support@larsa4d.com.

About LARSA Section Composer

LARSA Section Composer is powerful and easy-to-use software that is an essential graphical tool in the analysis and design of any bridge or building structure with nonstandard or nonprismatic sections. It supports nonprismatic and composite sections based on standard, parametric, and custom shapes, and it is able to compute section properties for standard as well as user-drawn shapes. The program also calculates the section properties of shapes that are needed in structural analysis, and it performs moment curvature analysis and ultimate strength check.

Sections made in Section Composer are modeled in an intuitive user interface which provides a variety of editing tools. A user-friendly and completely integrated format based on the same powerful LARSA 4D technology makes it an absolute must for LARSA 4D users.

Features:

- Adding custom sections to LARSA model.
- Built-up sections using any shape from AISC steel tables, standard AASHTO bridge girders, and LARSA's modifiable parametric shape tables.
- Build plate girders including box-girders and hybrid girders.
- Graphically create and edit any arbitrary shape by drawing with the mouse or specifying coordinates.

Overview

This section provides an overview of the terminology used in LARSA Section Composer.

Sections, Shapes, and Parameters

Sections are assembled by combining shapes, which may be taken from standard databases (including AISC, ARBED, CAND, EURO, and UK), created from parametric shape templates (I, T, pipe, several types of box girders, and more), or free-drawn. Section Composer automatically computes cross-section properties. A parametric section **database** contains one or more sections and is saved in a file with a .lpsx extension. Section databases can be connected to LARSA 4D projects where the section properties become available. LARSA 4D can also create rendered images of sections defined in Section Composer.

A **shape** is a polygon. The polygon determines the outline of the cross-section. Each point on the polygon has a z/y coordinate on the section canvas. Points can be positioned by entering coordinates, dragging them with the mouse, or using parameters and formulas.

The cross-section is solid unless a **cutout shape** is placed inside of it: the cutout shape defines the outline of the hole, like the hole in a box girder.

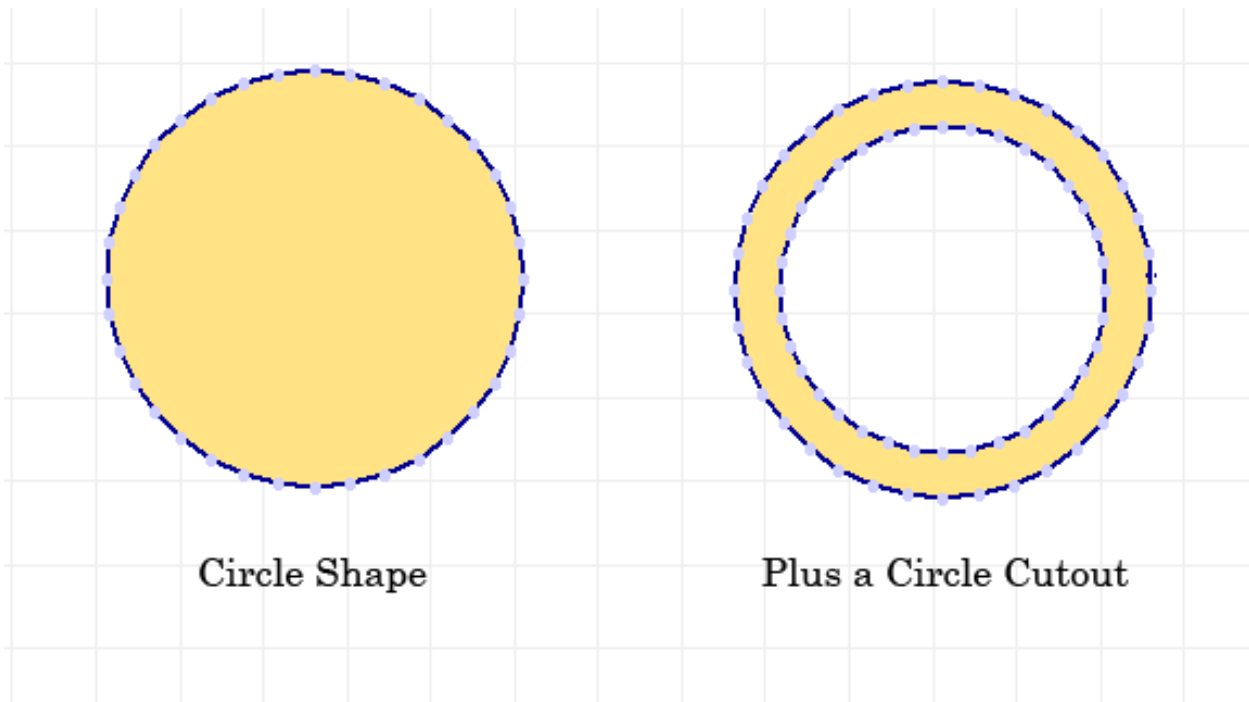

A cutout shape creates a hole within a solid shape.

Shapes can also be embedded within other shapes to model composite action. A **composite shape** (not to be confused with composite sections) is used if a shape has an internal part with different material properties.

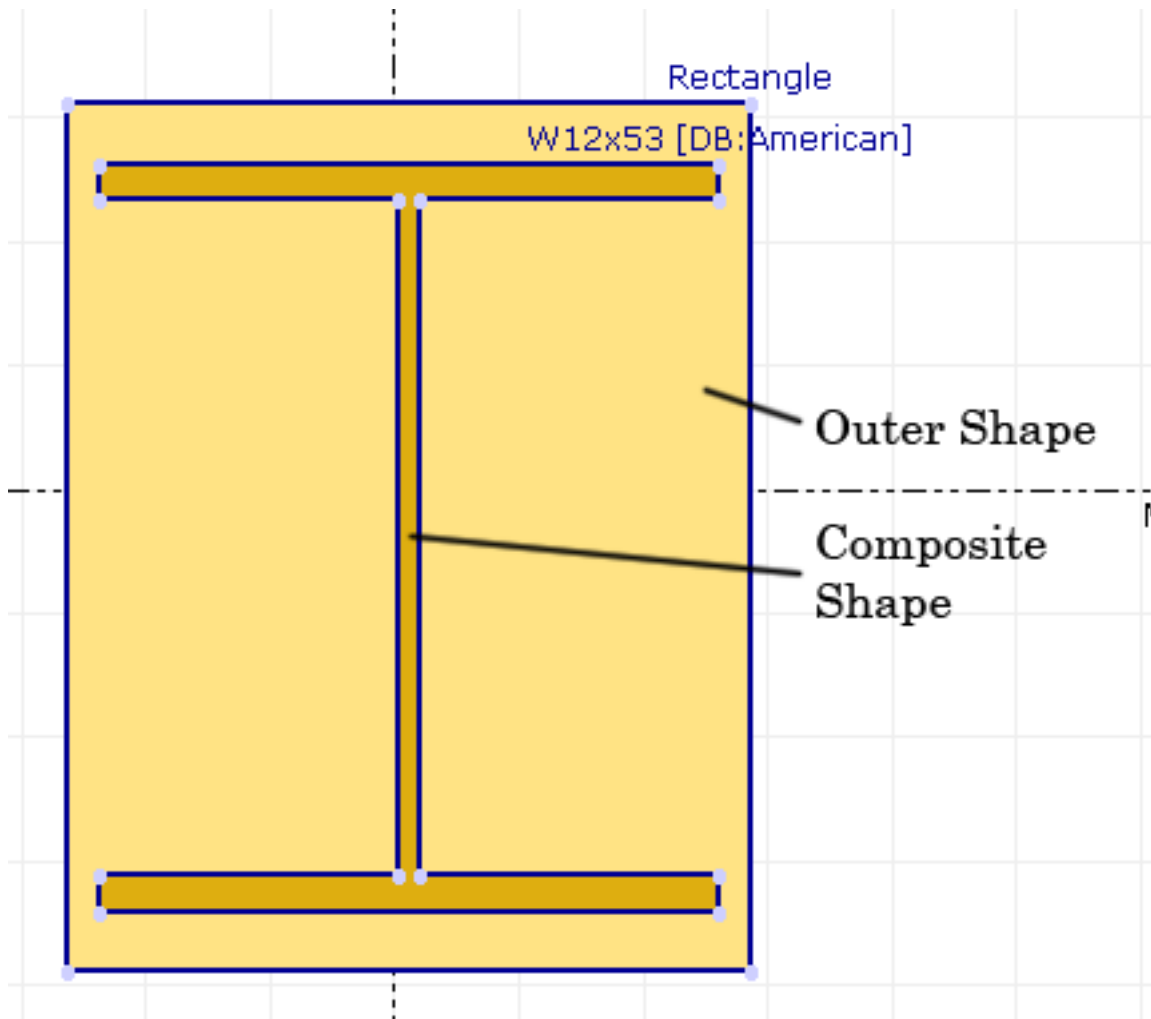

A composite shape is a shape embedded within another shape of a different material.

There are three ways the geometry of a shape can be set. *Standard shapes* are ones that come from a standard section database (e.g. AISC). The parameters and the point coordinates of standard shapes cannot be modified. Their analytic properties are read from the database as well.

Shapes where the z/y-coordinates of the corners of the polygon are entered directly are called *free shapes*. They are simply polygons with point coordinates. You can later on define parameters for a free shape and change the point coordinates to use these parameters.

Parametric shapes are sized according to length, width, and other easy-to-understand dimensions, rather than through coordinate points. A *parameter* is a placeholder for a dimension. *Formulas* can then be used based on this parameter to define the coordinates of a point. There are number of predefined parametric shapes available in Section Composer, but you can create your own by starting with free shapes and adding parameters and formulas after. An example of the parameters and formulas to define the 12 points around the perimeter of an I-shape is given in the figure below.

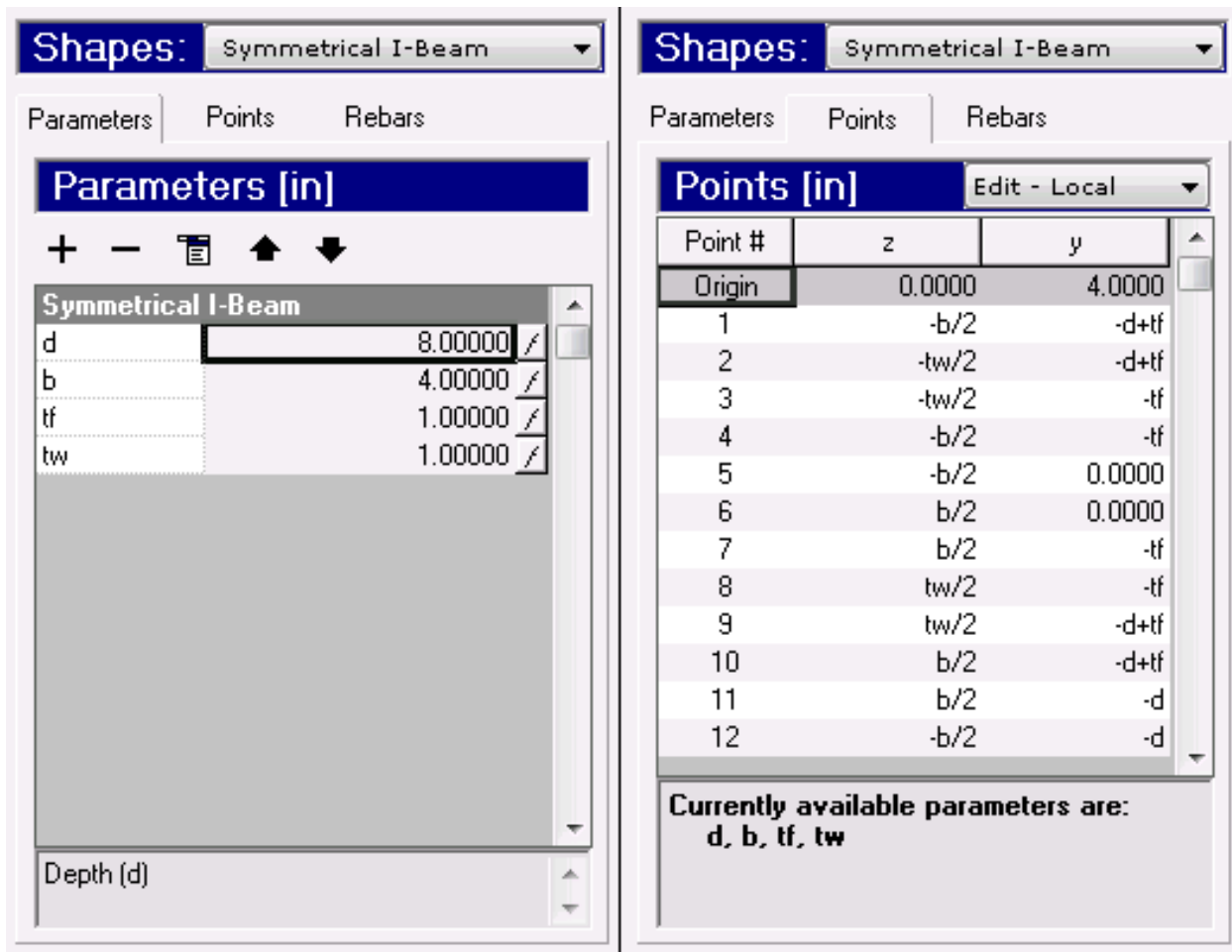

Parameters and point formulas for an I-shape.

We could define an I-shape by setting the (z, y) coordinates of the points clockwise around the perimeter. Each point could be entered as a coordinate. Starting at the top outer vertex of the lower left flange and working clockwise, the points might be (-2, -7), (-0.5, -7), (-0.5, -1), etc. (the top of the shape is at y=0). But if the dimensions of the box change later, you'll need to fix each of the twelve coordinates. Rather than explicitly inputting the coordinates, we use dimensions (parameters and formulas). That means we need to define the coordinates of the points not with actual numbers but with placeholders for the dimensions.

For a symmetric I-shape we four parameters: d for the depth of the shape, and b for the width, tf for flange thickness, and tw for web thickness. Using simple equations for each coordinate, the coordinates of the points can be set to (-b/2, -d+tf), (-tw/2, -d+tf), (-tw/2, -tf), etc.

We will return to how to enter this information into Section Composer later in this manual. Keep in mind that although the formulas used in this example are quite simple, the Section Composer uses an advanced formula language which is powerful enough to handle very complicated equations. It is described later in this manual.

Composite Sections

LARSA 4D and Section Composer starting with version 8.0 support two new types of composite sections. A composite construction section is one in which parts of the section are cast at different times. For instance, a web may be placed

before a deck is poured above it. A composite material section is one in which parts of the section are made up of different materials, such as a steel web with a concrete plate on top, which can respond differently to time-dependent material effects. (Versions prior to 8.0 also support a type of composite material section without material time effects and other effects that affect the parts of a section differently.) A section can also be both composite construction and composite material. These sections require special attention both for the user as well as for the program because their gross properties change over time and their parts respond to effects such as time-dependent material changes and thermal gradients differentially.

The use of composite sections serves as an alternative to two other possible modeling techniques. The first modeling technique is to model each composite part as a separate member element in LARSA 4D, i.e. making parallel girders for each composite part. Each part or member can be assigned a different material in LARSA 4D and can be constructed at different times using Staged Construction Analysis. In this way, the member elements each have constant properties throughout the cross-section; however, they will need to be tied at regular intervals to ensure they deform together (either using rigid elements, DOF constraints, or member end offsets). Ties add additional modeling complexity. The second modeling technique is to average the properties of the parts into an equivalent non-composite section. The advantage is the simplicity of a model with a single line of member elements representing what is conceptually a single girder. However, in this model parts cannot be constructed at different times and neither time-dependent material changes such as creep and shrinkage nor thermal gradient loads can be used.

Composite sections are a best-of-both-worlds approach. By allowing a single cross-section to be defined with different parts (i.e. shapes), only a single line of member elements need be created in the LARSA 4D model. to represent the whole girder. Because the parts are a part of a single cross-section, they will necessarily deform together. (During an analysis, the cross-sectional properties and the location of the centroid of each individual member element for the purposes of the assembly of the global stiffness matrix are computed as the equivalent properties as if the member had a uniform cross-section.) Additionally, construction activities in Staged Construction Analysis allow the user to change the cross-sectional properties of the members over time by constructing parts of the section individually. Self-weight, time-dependent material effects, and thermal gradient loads are computed for the parts of the section separately, allowing the parts to have different responses, and are then lumped onto the centroid of the combined, whole section.

Screen Overview

Section Composer's screen has menus, toolbars and explorers. Instead of a 3D graphics window, there is a 2D canvas to define a cross section. There is also the header bar where we can see the active section name and the mouse coordinates as we move our mouse on the graphics window. Instead of a window bar, a section list allows the toggling between sections defined in the same database file. An additional explorer called calculations can be found at the top right side of the screen and displays the properties of the current section in real time.

Section Axes

Section Composer shows a two-dimensional cross-sectional picture of the section. The y-axis of the member is the vertical axis and the z-axis of the member is the horizontal axis. We will always be dealing with the y- and z-coordinates in the Section Composer. The (0, 0) coordinate at the intersection of the y- and z-axes on the canvas is at the *member reference line*. This is like an x-axis that goes “into the screen.” The member reference line lines up with the line between the start and end joints of the member in the LARSA 4D model (assuming the member does not have member end offsets). We call these axes the *member reference axes*.

The *centroid* of the section will not necessarily fall on the member reference line. If shapes are placed off center, LARSA 4D will assume the user wants the physical member offset from the member reference line, which can be convenient for aligning the section with a bridge centerline or modeling nonprismatic variation. In most cases, the user must take care to place shapes so that the section centroid falls on the (0, 0) coordinate in the Section Composer window. When the section reference line and centroid do not coincide, the reference axes serves as the origin for

geometry including the alignment of the section and the placement of lanes and tendons, while the centroid serves as the origin of the member “local coordinate system” which is used for loads and results. This is discussed in more detail in the section on nonprismatic variation later in this manual.

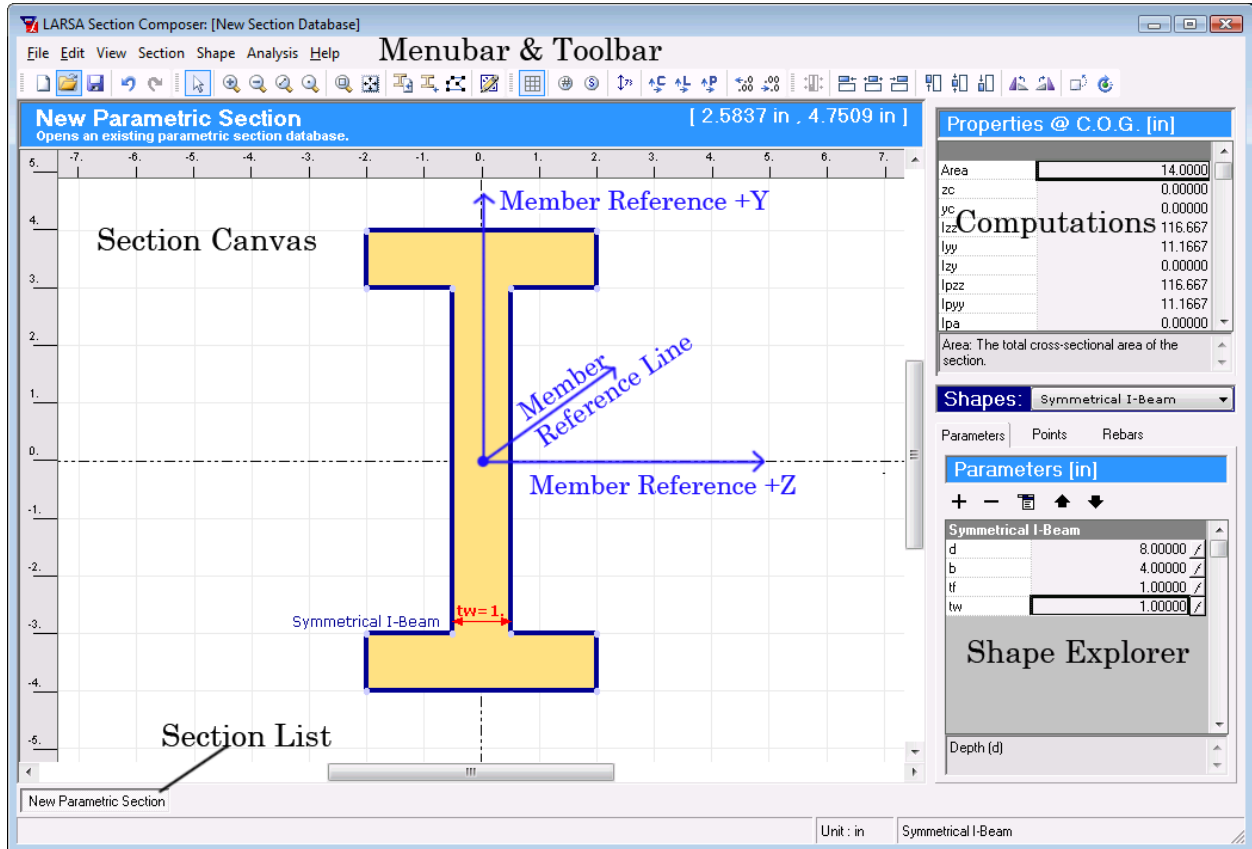

Screen overview and section axes

Creating a Section

Sections can be prepared in several ways. The tutorial below introduces Section Composer's basic functionality including setting database options, adding standard and custom shapes, editing shape dimensions with parameters, align and snap tools, setting stress recovery points, and using the section in LARSA 4D.

Starting Up

Let's go into the details of the program with a basic example. The first section we will create will be a steel I girder with a steel plate deck on top. The final section is shown below.

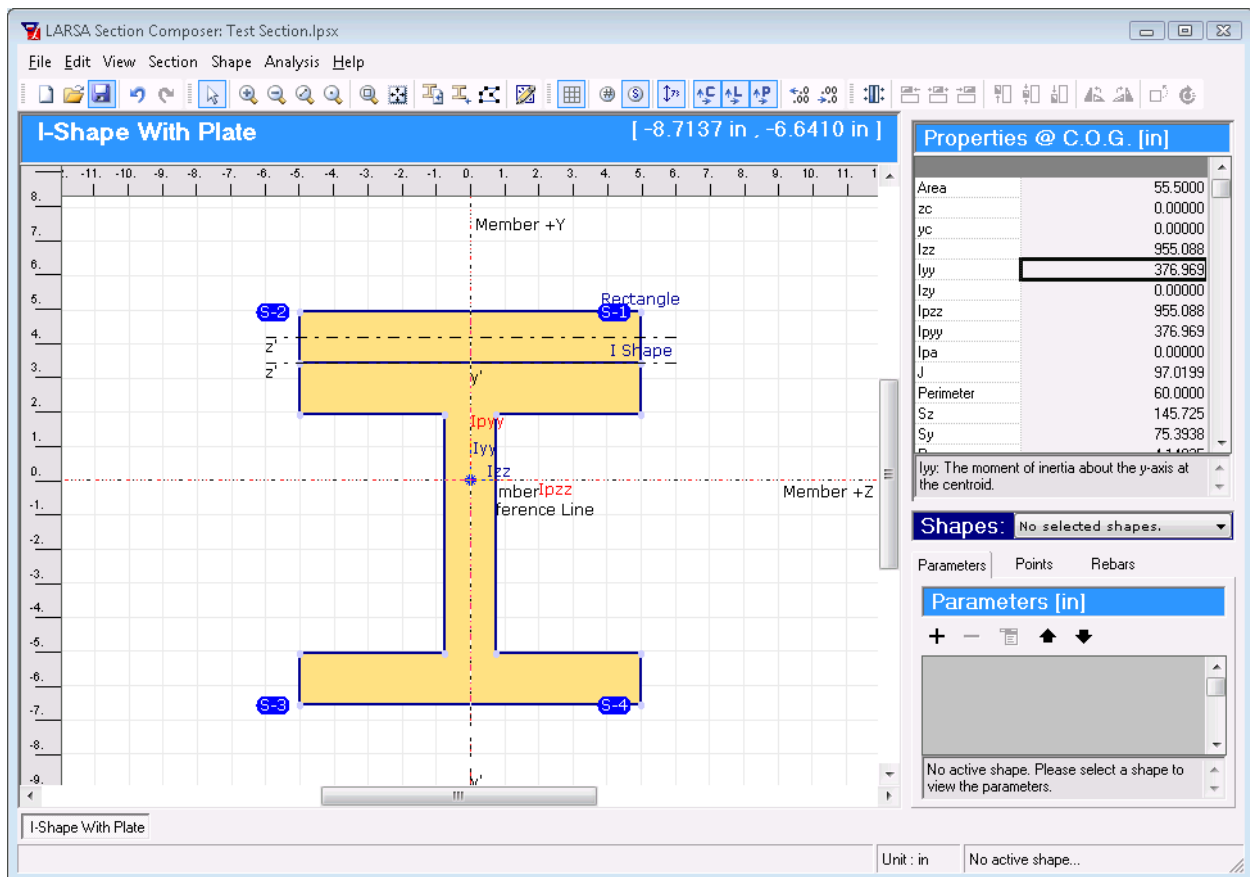

An example section

- ☛ If you do not have Section Composer open, from the start menu of Windows, go to Start → (All) Programs → Larsa 4D and select Section Composer. Otherwise, start a new database in Section Composer using **File** → **New**.

Notice that when a new database is opened, it automatically comes up with a new section called 'New Parametric Section' in it.

- From the menu go to **Section** → **Rename** and name this section 'I-Shape With Plate'.

Next we set up the units of this section.

- Go to **Section** → **Units**, and if it is not already selected, select inch as the section unit. Then click OK to close the window.

Next make sure that the grid is properly set up.

- Go to **View** → **Grid Setup** and set the grid width to 1 inch. Click OK to close the dialog.
- Also in the **View** menu, turn on all the options except the stress recovery points and the point numbers: Grid Lines, Dimension Lines, Shape Local Axes, Centroid Position, and Principal Axes.

We can now start adding some shapes into this section.

Adding Shapes

The **Shape** menu has several tools to add shapes to the section being edited. Any number of shapes can be added into a section.

The **Insert Standard Shape** tool in the **Shape** menu is used to add a predefined shape from a standard database, such as the AISC and Indian databases. Sectional properties and a preview of the shape are shown as the database shapes are browsed. The dimensions of standard shapes cannot be modified by the user once they are inserted into the section.

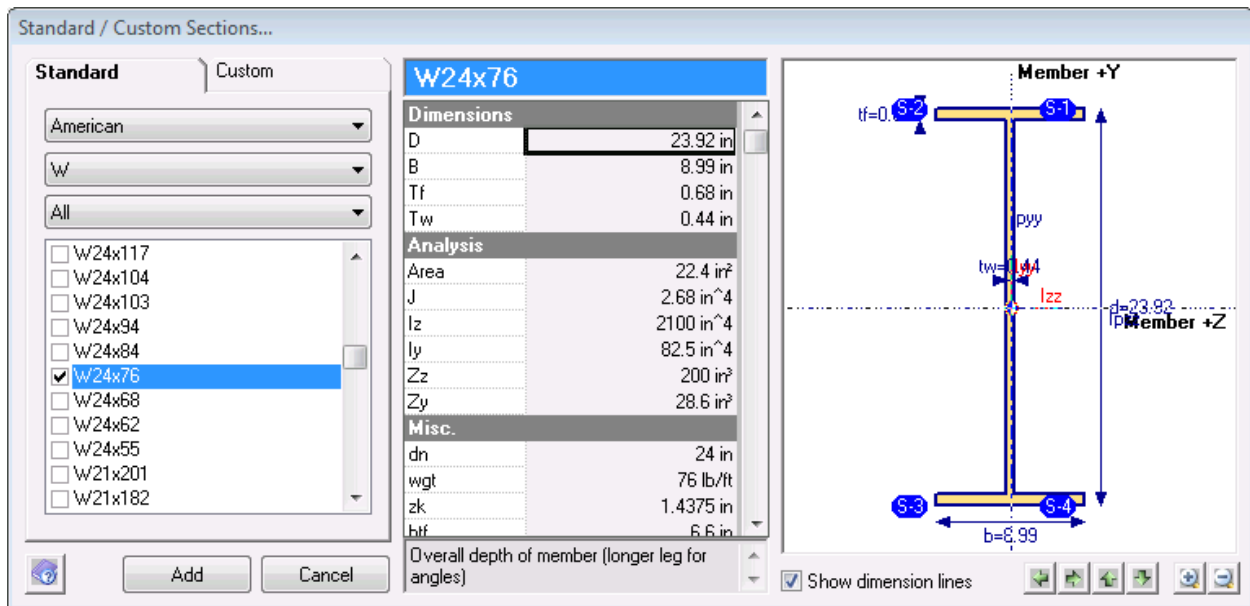

Adding a Standard Shape

For this tutorial, we will use the **Insert Custom Shape** tool in the **Shape** menu which is used to create shapes based on standard forms but with user-supplied dimensions. Thirteen basic shape types (I, rectangle, Angle, etc.) and many complex shape types are included with Section Composer. The complex types include code-based box girders and AASHTO-type I and T beams. The dimensions of custom shapes can be edited later on.

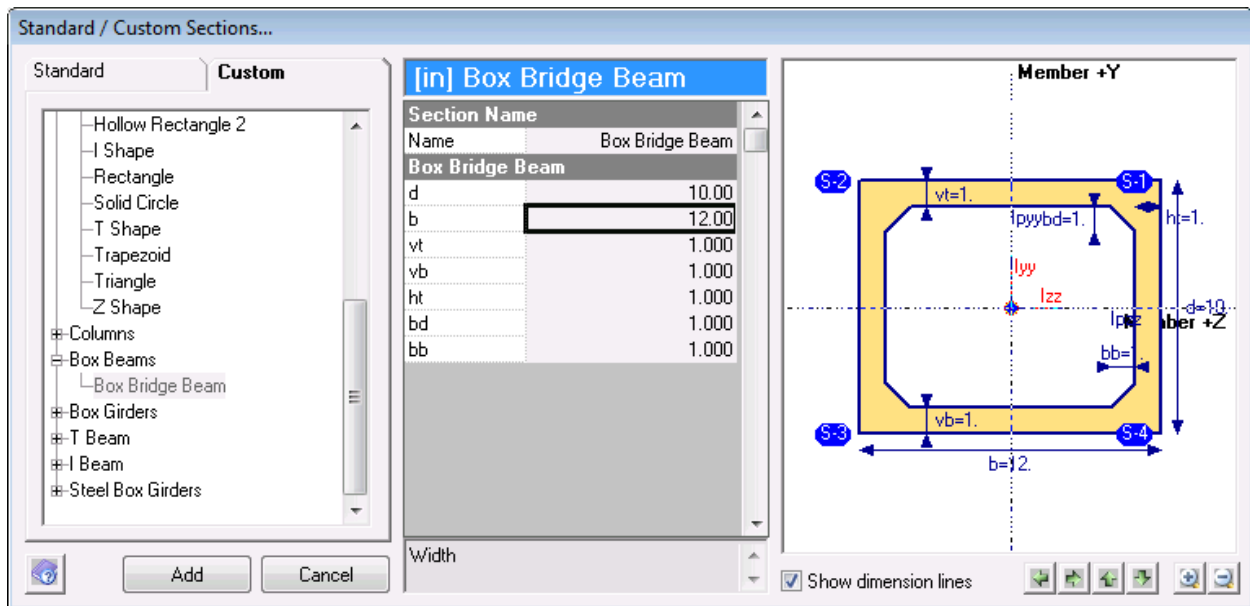

Adding a Custom Shape

When a section requires a shape that doesn't fit any of the provided templates, the **Draw Free Shape** tool can create a shape with arbitrary point coordinates. This will be demonstrated later on.

- Use the **Insert Custom Shape** tool to add an I-shape to the section. It will be found in the Basic Shapes category. Enter arbitrary dimensions for the parameters. As you click a parameter, a description of its meaning is provided below the parameters table. Click Add once the dimensions are set.

After adding a shape, you may want to give the shape a name. Shape names are used to identify shapes and to group parameters. To change a shape's name, right-click the shape and choose **Rename**, or use the **Rename** tool in the **Shape** menu.

- Use the **Insert Custom Shape** tool a second time to insert a rectangular shape (it is the Rectangle shape type in Basic Shapes) whose depth is on par with the I-shape's flange thickness and whose width is the width of that of the I-shape.
- Move the shapes around by dragging them with the mouse to position the rectangle above the I-shape. You may need to click the **Zoom Out** tool in the toolbar.

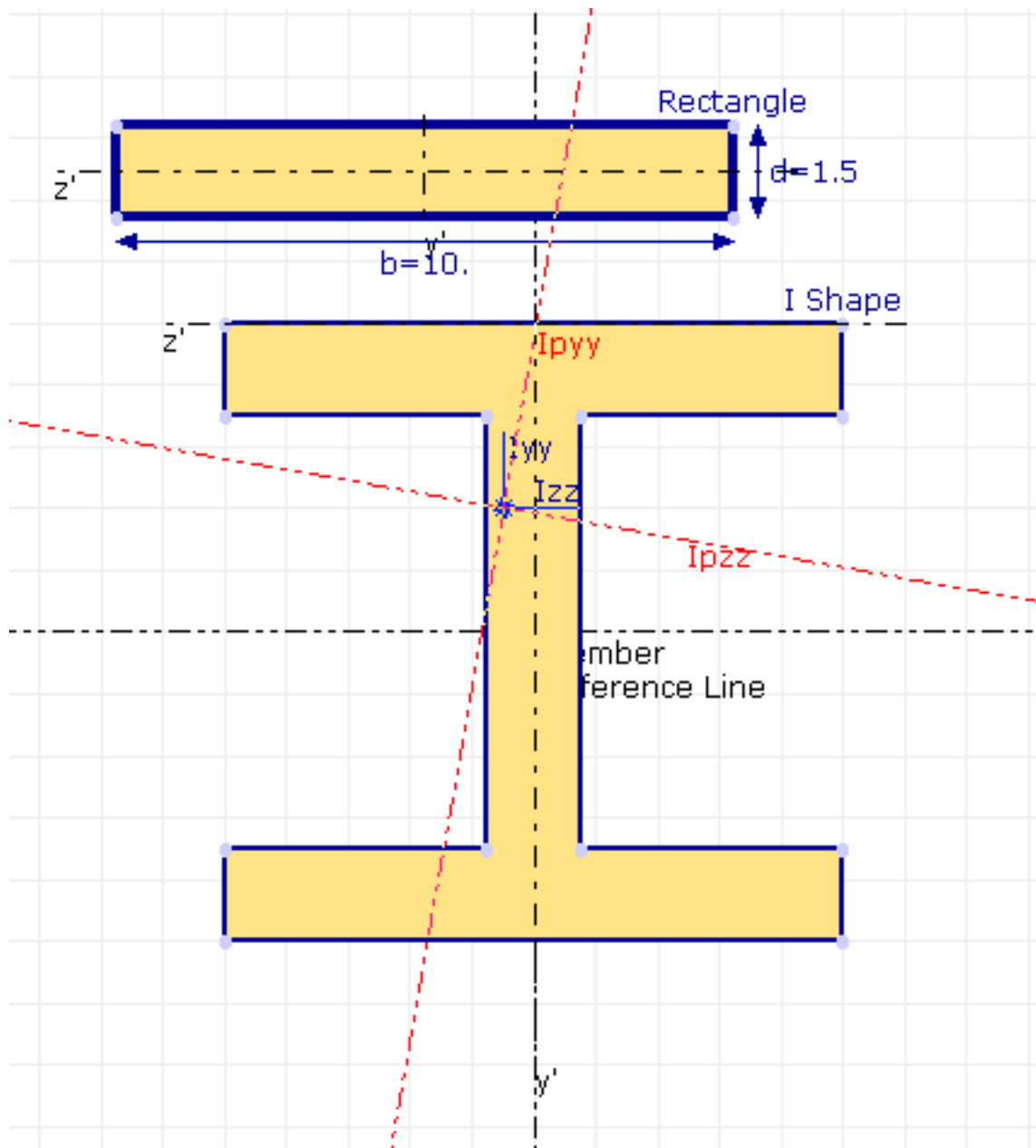

Adding Two Shapes

We do not set the material of shapes in the Section Composer when the material is uniform throughout. Rather, the material is specified in LARSA 4D.

The display canvas, as in the figure above, shows the centroid and principal axes of the combined cross-section. The centroid is indicated by the small blue I_{yy}/I_{zz} axes near the center. Note how it is offset from the Member Reference Line. We will correct this later on. (If the centroid is left where it is, it would define the member local coordinate system in LARSA 4D, which is different from the member reference coordinate system. Member loads and results are about the local coordinate system.) In the Properties Explorer, the values for I_{yy} and I_{zz} are the moments of inertia about these axes.

The principal axes of the section are also shown; however, these are informational and diagnostic only. Principal axes are not used in the LARSA 4D analysis. The principal axes are drawn with a red dashed line and are distinguished by the I_{py} and I_{pzz} labels. The principal axes are located at the section centroid but may be rotated from the member reference/local axes if the section's strong axis does not coincide with the member reference z axis.

Editing Shape Size and Position

Shapes are positioned and modified by selecting them. To select a shape, click on it. To select multiple shapes at once, drag a window with the mouse enclosing the shapes or hold the **CTRL** and click on multiple shapes.

The dimensions of shapes are set through parameters which are listed in the Shape Explorer on the right side of the screen, when shapes are selected. The parameters for I shapes are d, b, tf, and tw, for instance.

- ☛ To change the dimensions of a shape, click the shape to select it. Make sure the **Parameters** tab is active in the Shape Explorer, and then click the parameter to change in the parameters spreadsheet. Try changing some of the parameters of the shapes to resize them. A description of the parameter will appear below the parameters spreadsheet, and the corresponding dimension line for the parameter will appear in red in the drawing area.

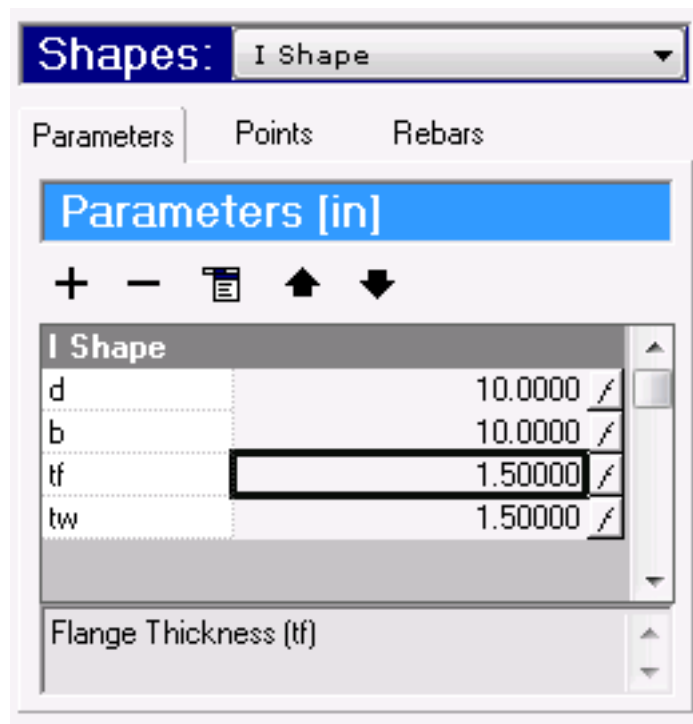

Parameters for an I Shape

Shapes are positioned either by dragging them with the mouse or by setting their origin coordinates. The origin is a reference point for each shape, and often but not necessarily the shape's center of gravity. It is indicated by dashed lines and y'/z' -labeled axes when the Local Axes display option is on. To turn on local axes, click **Shape Local Axes** in the **View** menu.

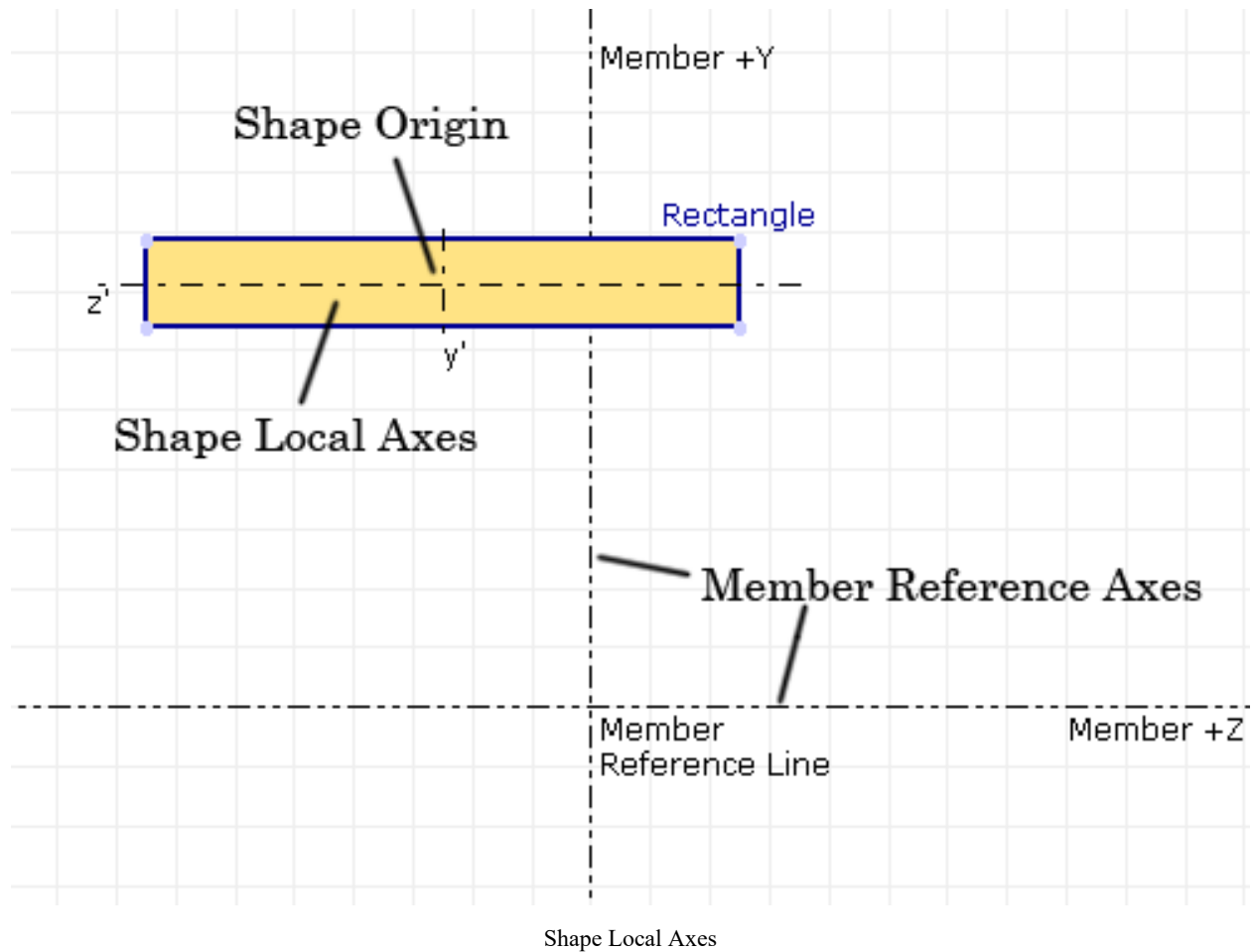

The origin coordinates can be set by going to the Shapes Explorer, changing to the Points tab, and making sure the View/Edit option reads Edit - Local. The origin coordinates are the position of the shape y'/z' origin relative to the Member Reference Line.

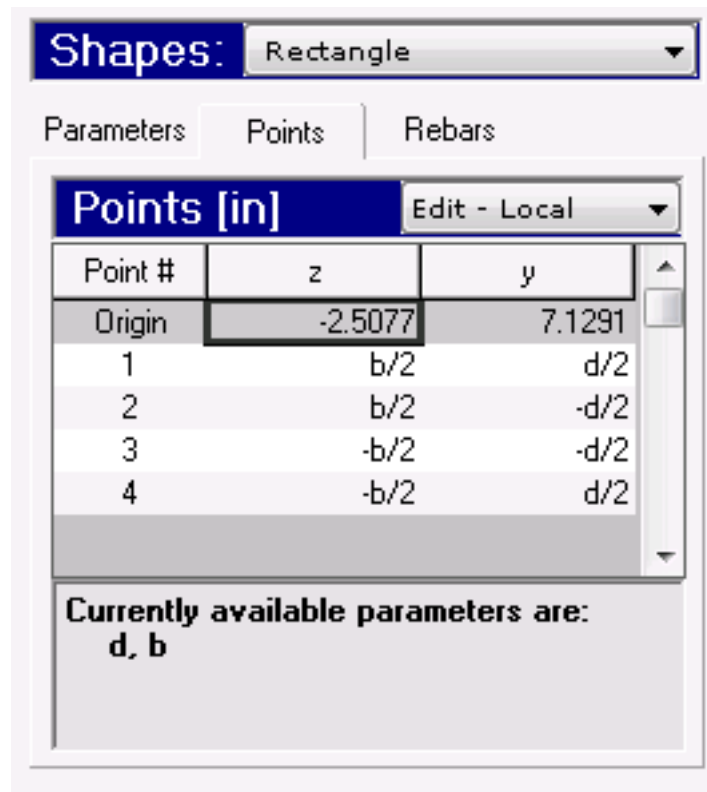

Editing the Origin of the Rectangle

It is up to the user to position shapes by dragging or setting origin coordinates so that the combined section centroid lines up with the Member Reference Line (which is almost always desired).

Align and Snap

Often two shapes in a section will have their edges aligned. A concrete plate sitting atop a beam will, for instance, have its bottom edge aligned with the beam's top edge. The six alignment tools on the toolbar are used to quickly put shapes side-by-side: align left, align horizontal center, align right, align top, align vertical center, align bottom. Each command aligns the indicate edge of the selected shape(s).

To align a shape, first make the shape selected by clicking it. Then click the align tool for the side of the shape to align. A menu will appear with a list of what the shape can be aligned to: another shape's corresponding side or the member axes.

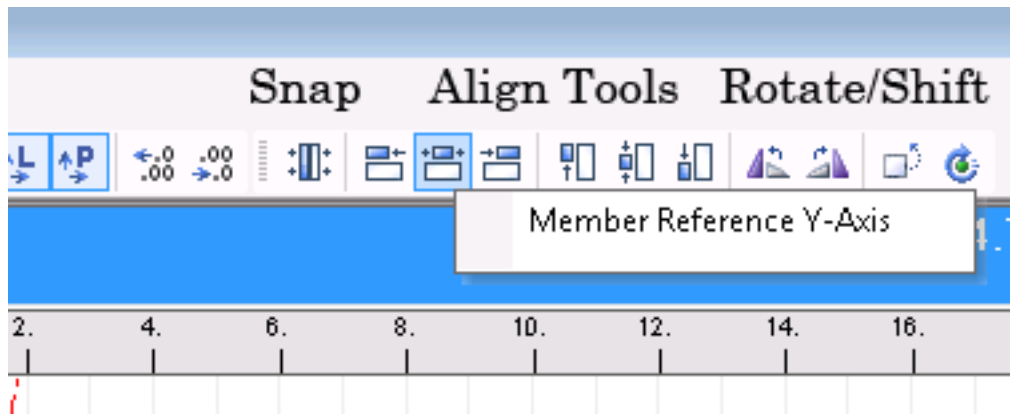

Align and Snap Tools

- Click on the rectangle shape so that it is selected. Then click the **Align Left**, the leftmost alignment tool, in the toolbar. The two choices are **Member Reference Y Axis** and **I-Shape - Left**. The first choice will align the left edge of the rectangle with the member's vertical reference axis. The second option aligns the left edge of the rectangle with the left edge of the I shape. Choose that.

The snap tool works like the align tool, but instead of choosing a common side of a shape to align, two shape edges are chosen and they are brought together. The two edges must be parallel.

- Click the snap tool in the toolbar to begin a snap operation. Then click the edge of the shape to be moved. In this example, choose the bottom edge of the rectangle. Last, click another edge where the first shape should be moved to. Here, click the top edge of the I-shape.

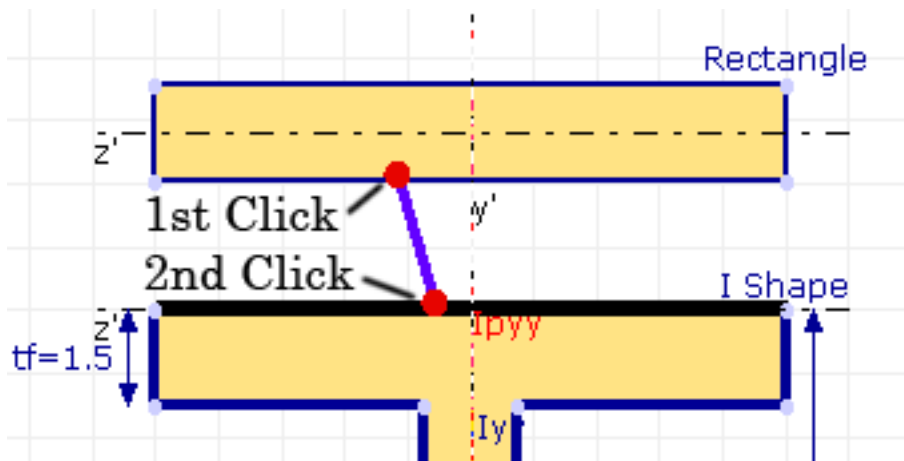

Using the Snap Tool

The two shapes are now connected appropriately.

We must now put the combined section centroid on the member reference line. The sections are currently positioned with the I-shapes center on the member reference line. But with the addition of the rectangle, the centroid moved up. The two shapes must be shifted down. Section Composer has a command to do this automatically.

- In the **Section** menu choose **Move Section Centroid to Member Center**. The shapes will be shifted into position.

Other Shape Tools

There are a number of other shape tools available that we will not need for this example. They can be found on the **Shape** menu or toolbar.

Shift

This command performs a translation on the selected shape. The user is asked for a distance along the z- and y-axes to shift the shape.

Rotate

This command rotates the selected shape by a specified angle in degrees.

Rotate 90 CW/CCW

This command rotates the selected shape 90 degrees either clockwise or counter-clockwise.

Flip Horizontal/Vertical

This command mirrors the selected shape either horizontally or vertically about its local axis.

Add/Remove Points(s)

This command adds or removes a point on the polygon that defines the selected shape's outline. It is generally used when creating a custom or free shape from scratch.

Reverse Point Order

When creating a new custom or free shape from scratch, this reverses the order of the points on the polygon of the selected shape. There is no rule about whether the points should be ordered clockwise or counter-clockwise. It is a matter of user preference.

Shift Points Forward/Backward

Again as a matter of user preference, this changes the numbering of the points on the polygon outline of the selected shape so that the first point becomes point number 2 (and so on for the other points) or the points are shifted so that the first point becomes the point numbered last (and so on).

Duplicate

This command duplicates the selected shape. It creates a new shape with the same parameters, points, and formulas but with a new name.

Merge

This command merges several adjoining shapes into a single shape. Select the shapes to merge before activating this command.

Stress Recovery Points

Before moving on to the next section, we need to define the stress recovery points. When the section is analyzed in LARSA 4D, the stresses will be reported at these points only. Typically, a section should have four stress recovery points, one in each quadrant at the most extreme fibers of the cross-section. Stress recovery points can be placed at any vertex on the perimeter of a shape.

 In the **View** menu, make sure **Show Stress Points** is turned on to display stress recovery point icons.

When we added the first shape, Section Composer chose stress recovery points automatically as the four outermost points of the I-shape. They are shown in blue filled ovals. S-2 and S-3, meaning the second and third stress recovery points, can remain as they are. S-1 and S-4 must be moved to the top right and left corners of the rectangle.

- ☛ To set the location of the first stress point, first click the rectangle shape to select it and then put your mouse on the top right point of the rectangle shape, the new location for the stress recovery point. Notice that if the mouse is on the shape, the cursor is a four-headed arrow. If the mouse is on a point, the cursor becomes a two-headed arrow. The mouse should be two-headed. Right-click and choose **Set as Stress Point** → **1 [Top Right]**.

The S-1 indicator moves to the new location. Stress points are generally set in counter-clockwise order on the screen starting at the top right. The first point is positioned in the +y/+z quadrant. The second point is positioned in the top left, the +y/-z quadrant. The third in -y/-z. And the fourth in -y/+z. The stress recovery points need not be positioned this way, but this convention is assumed when stress recovery points are used as references for the placement of lanes and tendons in LARSA 4D.

- ☛ Do the same to move S-2 to the top-left corner of the rectangle.

Calculate Section Properties

As the section is created, Section Composer continuously updates the computations displayed in the Properties Explorer. The definitions of these properties are included later on.

But because the calculation of the Torsion Constant (J) and Plastic Section Modulus (Z_z , Z_y) are advanced computations that cannot be computed immediately, they are not updated automatically. When they have not been calculated “N/C,” standing for “not computed,” is shown in the explorer.

- ☛ To have Section Composer compute the Torsion Constant and Plastic Section Modulus, click **Section** → **Calculate Section Properties**. The computed properties are then displayed in the explorer.

This is the last step in creating a basic section. The section database can be saved and then later attached to a LARSA 4D project.

- ☛ Save the section database as "Test Section.lpsx".

Other Section Tools

Several other section tools are available that we will not need in this example.

The **Duplicate** tool in the **Section** menu (as opposed to the duplicate tool in the shape menu) duplicates the entire cross-section definition including all shapes in it as a new section in the same database. Duplicating a section is a good way to start a new similar section with different dimensions.

File → **Import** can be used to add a shape to the section from either an AutoDesk DXF file or another Section Composer LPSX database file.

File → **Export** can be used to export the section either as an AutoDesk DXF file or as an image file (BMP format).

File → **Report** creates a printable report for all sections in the open section database file. The report includes a diagram of each section, cross-sectional properties, and parameter settings.

Using the Section in LARSA 4D

The section is saved in an "LPSX" database file that needs to be linked into LARSA 4D projects that will use the section.

- ☛ Open LARSA 4D. It is not necessary to close LARSA Section Composer.

A section database is first connected to a LARSA 4D project. Once the database is connected, the sections defined in the database become available to assign to members.

- Use the **Connect Databases** command from the **Input Data** menu. Choose **Connect User Database**. Select the section database file, in this example "Test Section.lpsx".

The section(s) in the database are then added to the list of sections in the project. You can view the section from **Input Data** → **Properties** → **Sections** or in the Model Data Explorer.

The section is applied to members just as with standard sections, using the Model Data Explorer or the geometry spreadsheet.

Because of LARSA 4D's conventions for member local axes, an orientation angle of 90 degrees must be set on horizontal members to have the section oriented with its +y side up.

A nice feature of using Section Composer sections is that they render their true shapes when Complete Rendering is turned on.

- Add a member to the project and assign it the section from the section database. Set its orientation angle to 90 degrees. Click **Graphics** → **Complete Rendering**.

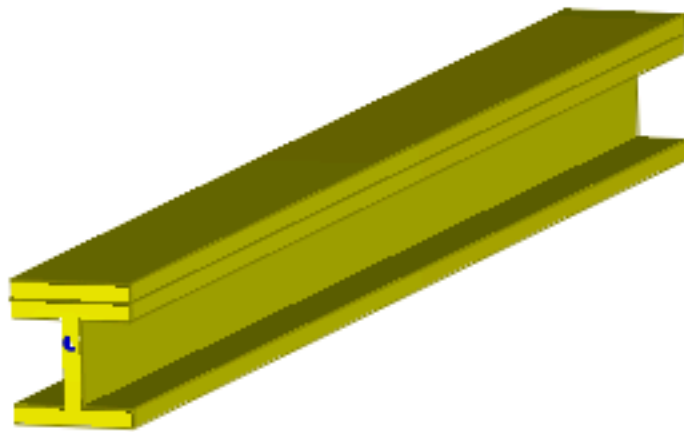

The section can be rendered in LARSA 4D.

Section Computations

The Section Composer is able to compute many properties of section definitions in real-time, for arbitrarily-shaped cross-sections.

Section Properties

The following computations are made for the sections. Details on some of these computations are listed below. The units of the computations are all in the length unit chosen in [Section](#) → [Units...](#).

The member local axis, referred to below, is at the section centroid with axes parallel to the member reference axes.

- **Area.** The cross-sectional area of the section.
- **zc, yc.** The coordinates of the centroid of the section which determines the location of the member local axes, with respect to the position of the member reference line. The reference line is the imaginary joint-to-joint line, plus any specified member end offsets, in LARSA 4D.
- **Izz.** Moment of inertia about the member local z-axis (at the centroid).
- **Iyy.** Moment of inertia about the member local y-axis (at the centroid).
- **Izy.** Product of inertia for the member local y- and z-axes (at the centroid). It is zero if the principal axes correspond to the local axes. It is not used in the LARSA 4D analysis.
- **Ipzz.** Moment of inertia about the principal z-axis. The principal axes are not used in the LARSA 4D analysis (only Iyy and Izz about the local axes).
- **Ipyy.** Moment of inertia about the principal y-axis. The principal axes are not used in the LARSA 4D analysis (only Iyy and Izz about the local axes).
- **Ipa.** The angle between the member local z-axis and the principal z-axis, giving the orientation of the principal axes. The principal axes are not used in the LARSA 4D analysis (only Iyy and Izz about the local axes).
- **J.** Torsion constant, described below.
- **Perimeter.** The perimeter of the cross-section, including the perimeter of any holes in shapes.
- **Sz.** Elastic section modulus about the member local z-axis (Izz divided by the distance from the centroid to the furthest edge in the y direction).
- **Sy.** Elastic section modulus about the member local y-axis (Iyy divided by the distance from the centroid to the extreme edge in the z direction).
- **Zz.** The plastic section modulus about the member local z-axis.
- **Zy.** The plastic section modulus about the member local y-axis.
- **Rz.** Radius of gyration about the member local z-axis ($\sqrt{Izz/Area}$).
- **Ry.** Radius of gyration about the member local y-axis ($\sqrt{Iyy/Area}$).
- **Qz.** Moment of area about the member local z-axis.
- **Qy.** Moment of area about the member local y-axis.
- **WeightArea.** Adjusted cross-sectional area factored by material density. When shapes are set to have different materials, creating a composite section, the weight area reports the sum of the shape areas factored

by the ratio of the shape density to the density of the chosen base material. WeightArea is used for the computation of self-weight in LARSA 4D version 7. In version 8, this field is not used in the analysis as the self-weight of each shape is applied independently.

- **Clz.** The horizontal distance from the right edge (+z) of the section to the centroid. The right edge is determined by the rightmost fiber.
- **Cty.** The vertical distance from the top edge (+y) of the section to the centroid. The top edge is determined by the topmost fiber.

When Principal Axes are turned on in the View menu, the direction of the principal axes of the section are drawn at the section's centroid. However, the principal axes are not used in the LARSA 4D analysis. Only Iyy and Izz about the local axes are used. Sections should be modeled such that the member local axes and the principal axes are coincident, if possible.

When the section includes shapes with different materials (see Composite Material Sections (page 59)), the properties are the transformed properties relative to a reference material chosen by the user.

Section properties do not consider the presence of rebar unless the **Include rebar in transformed section properties** option is turned on in **Section** → **Composite Materials...**. When this option is on and rebar is present, a material must be chosen for all section shapes, including rebar, and a reference material must be selected.

Computing section properties

As the section is created, Section Composer continuously updates the computations displayed in the Properties Explorer. But because the calculation of the Torsion Constant (J) and Plastic Section Modulus (Z_z , Z_y) are advanced computations that cannot be computed immediately, they are not updated automatically. When they have not been calculated "N/C," standing for "not computed," is shown in the explorer. To have Section Composer compute the Torsion Constant and Plastic Section Modulus, click **Section** → **Calculate Section Properties**. The computed properties are then displayed in the explorer.

Torsion Constant

A torsion constant J can only be sensibly computed in certain circumstances. Sections should be *entirely connected*, meaning there should not be two pieces of the section which are not connected by some material. When a section is composed with two disconnected parts, the torsion constant calculated will be the sum of the torsion constants calculated for the two parts, as a rough approximation of the true value.

When a section is composed of multiple parts but intended to be a single piece for the computation of the torsion constant, the shape point coordinates at the intersecting edges of two shapes should be exactly matching. The edges can be aligned with the help of Align and Snap (page 13).

Rebars (page 41) do not affect the computation of the torsion constant even if **Include rebar in transformed section properties** is turned on.

Shear Area Factors

Shear Area Factor Y and Z can be entered by the user. These parameters facilitate the computation of shear areas. Shear area is computed as the cross-sectional area multiplied by the shear area factor, in the y and z directions.

Free Shapes, Cutouts, and Composite Shapes

In a previous section, standard and custom shapes were used to build up a section. In this section three more shape types, free shapes, cutouts, and composite shapes will be used.

This section will build a tube section with dimensions 20 in. x 20 in. and a thickness of 2 in. This shape can be found in the custom section command (see [Creating a Section](#) (page 13)). Instead, we will create all the shapes of this section using only the free draw method. The outer perimeter of the section will be set by first drawing a *free shape*. The perimeter of the hole will be set using a *cutout* shape. Cutouts are shapes that create holes within other shapes. Without a cutout, all shapes would be solid.

Drawing the Outer Rectangle

When a section requires a shape that doesn't fit any of the provided templates, use the free shape tool to create a shape with arbitrary point coordinates. First we will start with the outer shape of the tube.

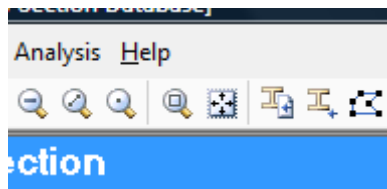

Free Draw Tool

- ◆ From the toolbar click the free draw tool. It is shown in the figure above.
- ◆ Click in the drawing canvas where the corners of the shape should be, one-by-one. Use the guidance of gridlines and make sure to verify the coordinate under your mouse in the header bar before clicking. Click in the canvas at (-10, 10), then at (10, 10), (10, -10), and (-10, -10).

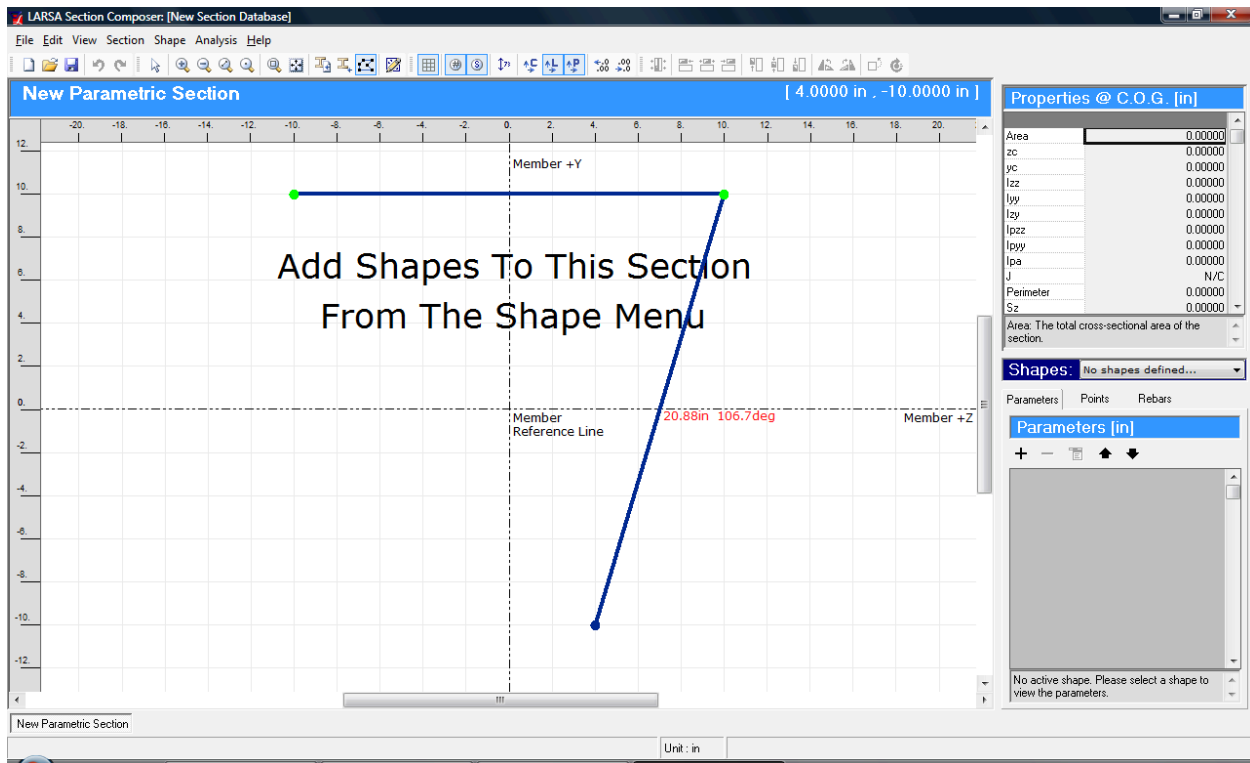

Using the Free Draw Tool

- ☞ After clicking all of the corners, click the first corner again to indicate that the shape is complete.

Now we have our outer rectangle. Take a quick look at the properties explorer on the right hand side at the top. You will see that as soon as we create a shape, the values in the properties explorer have changed to reflect the changes made to the section. What we have at this point is a solid rectangle and that is what the properties explorer is showing.

Also look at the parameters explorer, notice that we have no parameters defined for this section. Switch to the points tab. You will see that all the points are defined using numeric values. Shape point coordinates are relative to the shape's own local coordinate system, rather than the member reference line. This allows the shape to be repositioned, by editing the shape's origin coordinates, without affecting its own geometry. The location of the origin is editable in the first row of the points tab. It is relative to the member reference line

Keep in mind that on this explorer you can modify the coordinates, add/remove points, and copy/paste data (perhaps from another program like Excel). Also notice that the coordinates of the points can be viewed and edited in the shape's local axes or viewed relative to the member reference axes ("global").

After adding a shape, you may want to give the shape a name. Shape names are used to identify shapes and to group parameters.

- ☞ Change the name of the shape we just created using either of these methods: Right-click the shape and choose **Rename**, and then enter "Outer". or, use the **Rename** tool in the **Shape** menu and enter "Outer".

Drawing the Cutout

Although cutouts are part of the section with no actual material, their dimensions are given as shapes. This allows their dimensions to be controlled parametrically if desired in addition to the geometry of the outer perimeter of the shape. An outer shape can contain any number of cutouts.

- ☛ Create a cutout in the rectangle by right-clicking it and choosing **Insert Cutout** → **Draw Free Cutout**. This will allow you to click on points within the rectangle that define the interior perimeter. It is also possible to insert cutouts based on standard shapes.

Given the thickness of the tube as 2 inch, we need a 16x16 cutout inside the outer shape.

- ☛ Again using the help of the grid lines, click points at (-8, 8), (8, 8), (8, -8), and (-8, -8). Do not forget to click to the first point to finalize the drawing.

If by any chance you clicked an incorrect coordinate, press **ESC** on the keyboard to cancel the drawing or if you have already finalized the drawing but the shape has invalid points right-click on the cutout and choose **Delete** to remove it. Then start the cutout again.

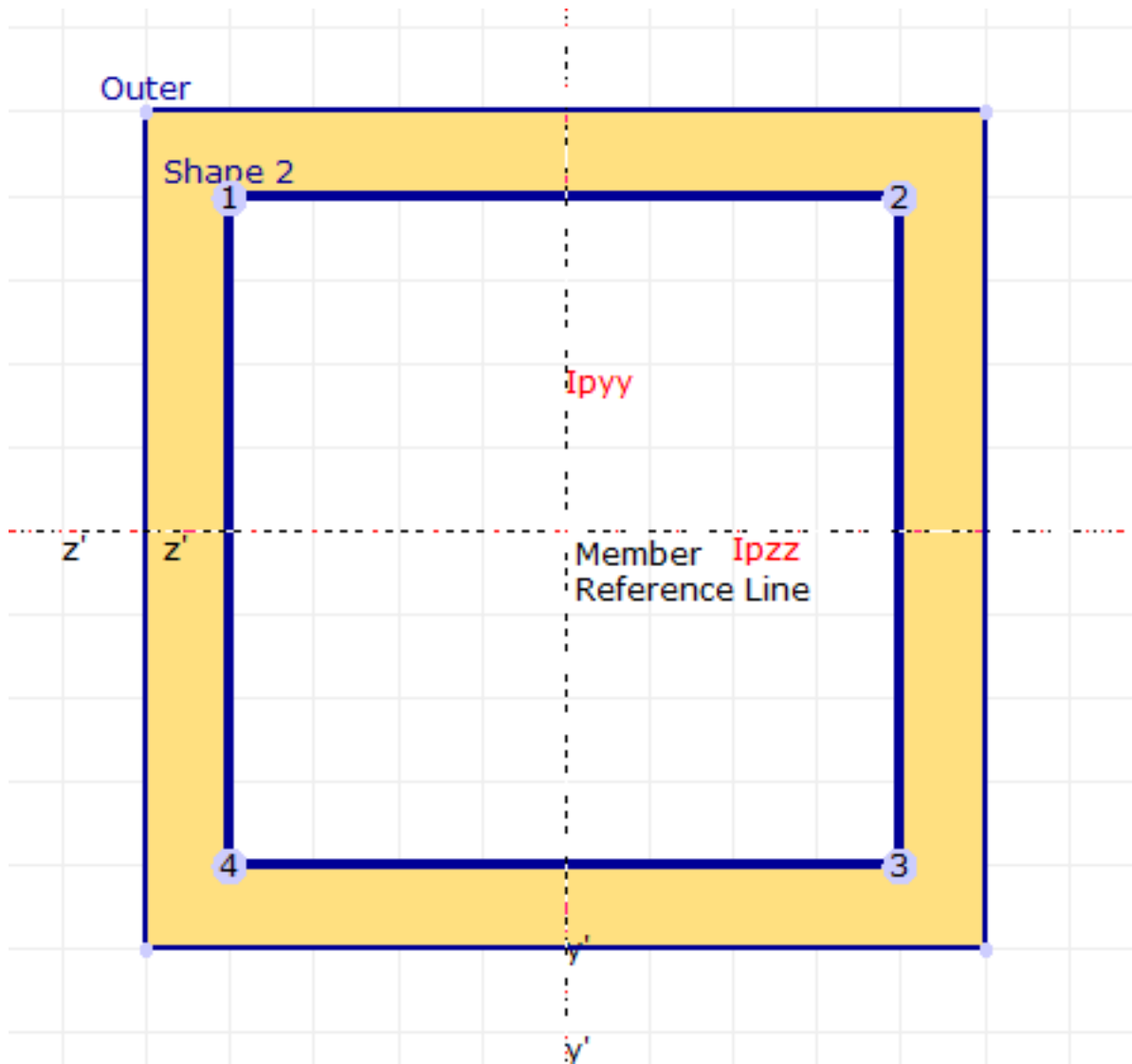

The tube section after creating the cutout shape

You will see the tube on the canvas. You can also see that the properties of the section have changed in the Properties Explorer at the upper right of the Section Composer screen.

The only property that is not shown is the torsion constant J , as discussed in [Creating a Section](#) (page 13).

Notice how the points spreadsheet in the shapes explorer now shows the points of just the cutout shape. The explorer shows the points of the selected shape. Click the solid portion of the tube to select the outer shape. Then click in the empty space to select the cutout again. Try editing the coordinates of these points to change the interior perimeter of the tube. Reset the values as above when you are done.

Starting a Section Section

A single Section Composer database file may contain more than one section definition. We will put the tube shape on hold and create a second section in the same database for a composite section.

- ☛ Rename the section to Tube using **Section** → **Rename...**.
- ☛ Start a new section by clicking **Section** → **Add New**. Give it the name Composite Section Example.

Notice how the two sections are listed in the section list at the bottom of the Section Composer screen. You can switch between editing the two sections by clicking their names. When the database file is saved, it will contain both sections.

Composite Shapes

- ☛ As before, create a 20 in. x 20 in. solid rectangle shape. You can use either the free draw or the custom shape tool.

A composite shape is placed inside a shape to indicate that part of its volume is made up of a different material from the outer shape. The composite shape gives the perimeter of this material. As with cutout shapes, the outer shape can contain any number of composite parts.

This example will model a steel rectangular core surrounded by a rectangular concrete form. The outer shape is the concrete part. The cutout to be drawn will be specified to have a steel material.

- ☛ Right-click the rectangle shape and choose **Insert Composite Subshape** → **Draw Free Composite Subshape**. Click four points (and then the first again) to create a shape within the rectangle that will have a different material.

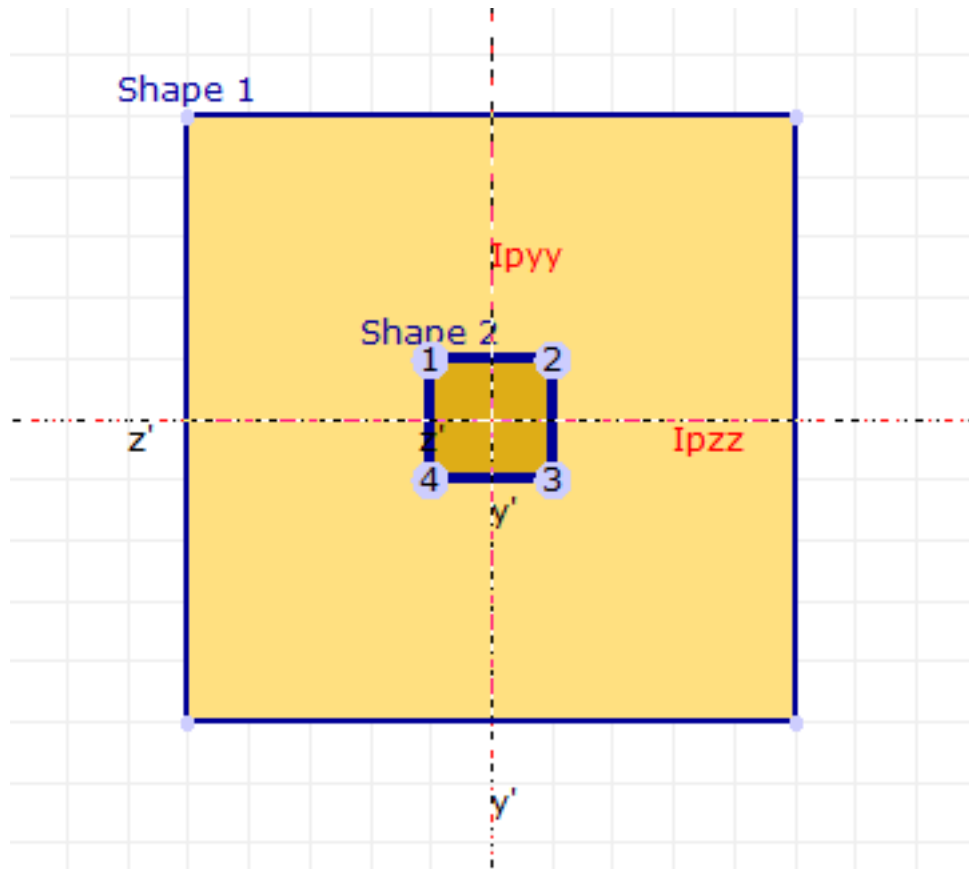

The composite material section with an outer shape and an inner composite part

The composite shape part is represented on the canvas as a different color, although we have not specified that the shapes have different materials yet. As it is now, the two shapes have the same material.

- ☛ Click the outer shape and rename it to Outer. Then click the composite shape and rename it to Inner.
- ☛ Go to **Section** → **Composite Materials...**. For the Outer shape, choose a concrete material. For the Inner shape, choose a steel material. Then click Close.

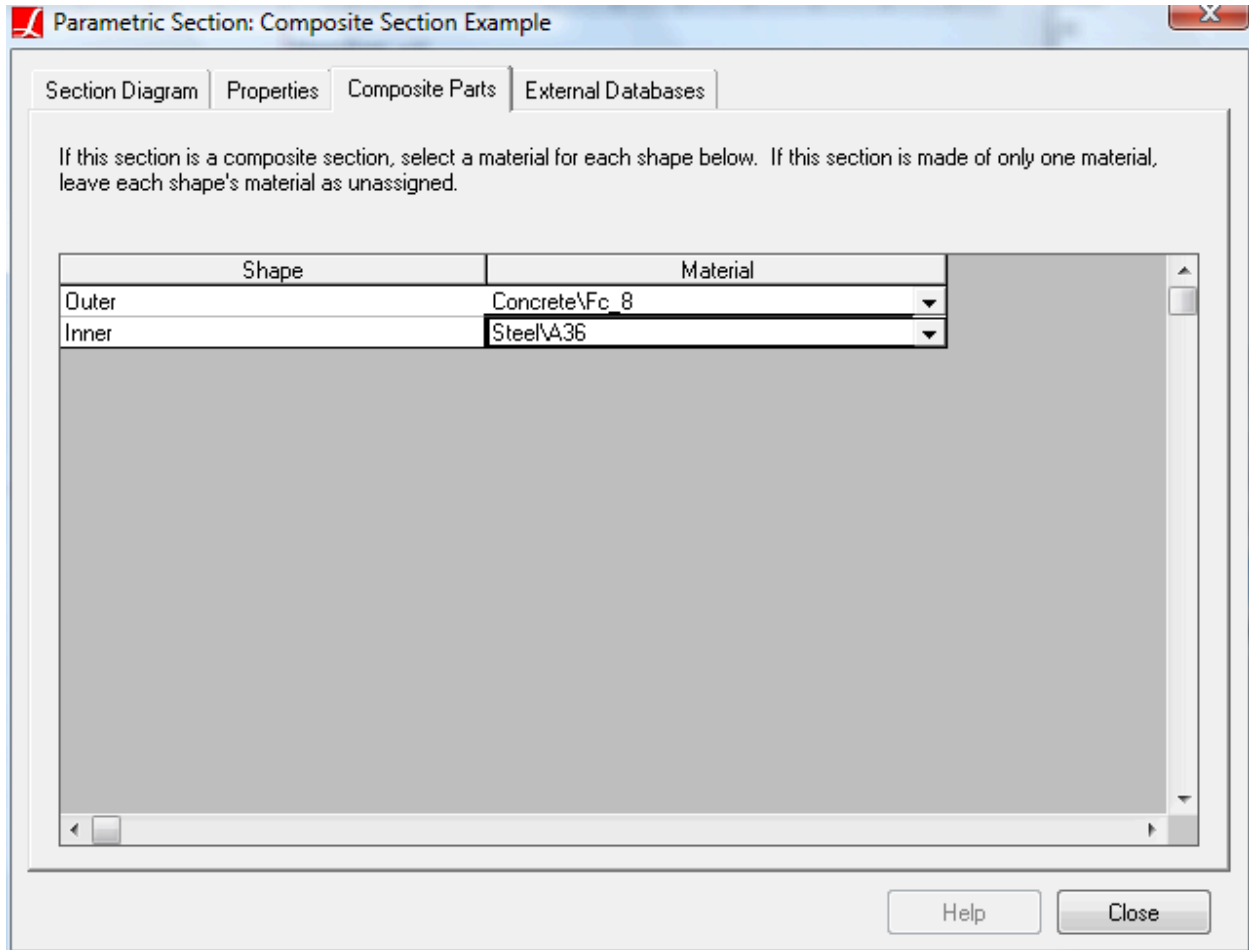

Selecting materials for the composite parts

The Properties Explorer has a new option: reference material. You must now choose a reference material for the section. The cross-sectional properties are computed as if the section had this material uniformly throughout by factoring the cross-sectional properties of the parts with other materials according to their modulus of elasticity.

In LARSA 4D version 7, this base material **must** also be set as the material of the members which will be assigned this section property. In version 8, the material field on members with composite shapes must be left as "none" as LARSA will choose a reference material automatically.

Properties @ C.O.G. [in]	
Reference Material:	Fc_8
Area	475.016
zc	0.00000
yc	0.00000
Izz	13,433.4
Iyy	13,433.4
Izy	0.00000
Ipzz	13,433.4
Ipyy	13,433.4
Ipa	0.00000
J	22,637.7
Perimeter	80.0000
Sz	1,343.34
Area: The total cross-sectional area of the section.	

The Properties Explorer has an option to choose a reference material when shape materials are set. More details on the use of composite shapes is given in Composite Material Sections (page 59).

Parameterizing the Section

The next section will discuss how to parameterize the tube section.

Parameters and Formulas

Parametric sections are created through the use of parameters and formulas which allows section dimensions to be altered parametrically without the need to alter point coordinates. This section explains more about the use of parameters and describes the formula language.

Parameterizing the Tube Section

In the last section, a hollow tube section was created using the free draw tool. This tool creates a shape in which the points are located with numerical coordinates. If the dimensions of a shape need to be revised, the coordinates of each of the point defining the perimeter of the shape will need to be updated with new values. By making the coordinates determined in terms of a formula, only a few section parameters need to be revised, and not each coordinate, in order to change the dimensions of the section. Parameters are also important in defining nonprismatic variation.

We will revise the tube section so that its points use parameters and formulas. Three parameters will be used: depth (d), width (b), and thickness (t).

From the parameters, the coordinates of each of the points can be computed automatically.

- ◆ Click the solid area of the section to select the outer shape.
- ◆ To create a parameter, go to the Parameters tab in the Shapes Explorer. Click the plus sign button.
- ◆ The first parameter to create will be depth. For the name, enter “d”. For value, enter 20, for the current value of 20 inches. In the description field, enter “depth”.

Leave two other parameter fields as they are: The shape field will be discussed below. The unit type field is only used for saved shape templates.

The image shows a dialog box titled "Edit Parameter...". It has several fields: "Shape" is a dropdown menu with "Outer" selected; "Name" is a text input field with "d"; "Value" is a text input field with "20"; "Unit Type" is a dropdown menu with "Length" selected; and "Description" is a text area with "depth". At the bottom, there are "OK" and "Cancel" buttons.

Creating a parameter for depth

- ◆ Click Add and then create two more parameters, b for width with value 20 and t for thickness with value 2.

Although this creates parameters, the eight points that make up the section still use numeric coordinates. The next step is to replace the numeric coordinates with formulas.

- ◆ Open the Points tab of the Shapes Explorer. Make sure Edit - Local is chosen. In this mode, the coordinates can be edited. Local indicates that the coordinates are relative to the shape's local coordinate system origin point.
- ◆ Replace the z-coordinate of point 1, which reads -10, with “-b/2”. Recall that b is 20, so the value should be unchanged when the formula is entered. If the shape's dimensions change in the graphical view, something is wrong.
- ◆ Replace the y-coordinate of point 1 with “d/2”.
- ◆ Replace the coordinates of the remaining points: (b/2,d/2), (b/2,-d/2), and (-b/2,-d/2).

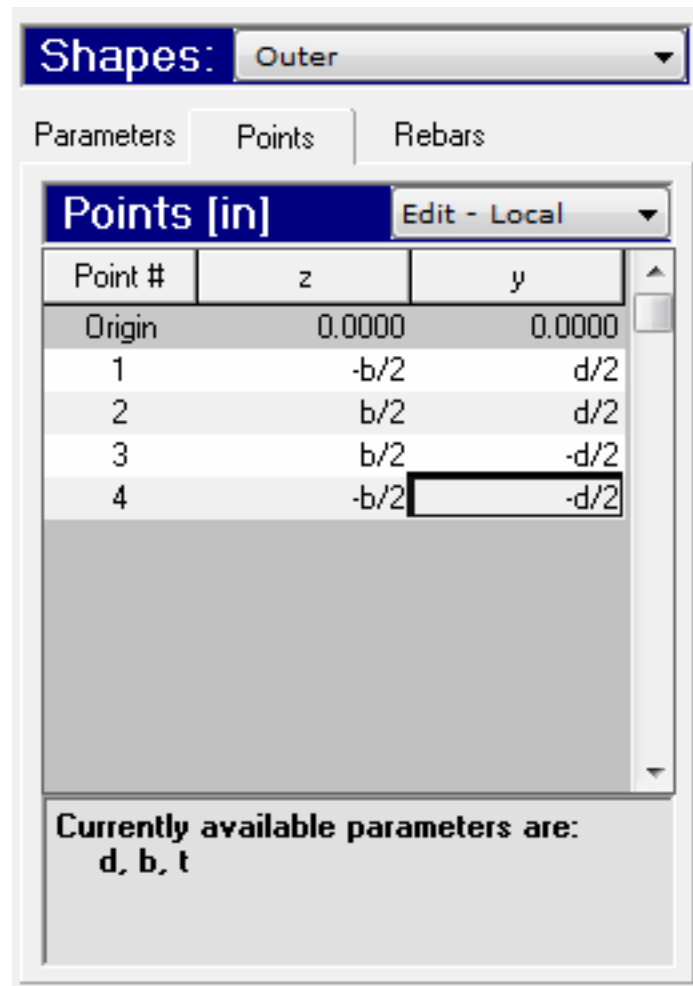

Parameterized coordinates for the Outer shape

- Click the empty space within the cutout to select the Inner shape. Then replace the numeric coordinates with $(-b/2+t, d/2-t)$, $(b/2-t, d/2-t)$, $(b/2-t, -d/2+t)$, and $(-b/2+t, -d/2+t)$.

The shape is now completely parameterized. Return to the Parameters tab and try changing the parameters to see the dimensions of the shape change.

Parameter Scope

Each parameter has what is called its scope. Parameter scope determines which shapes the parameter can be used in and is chosen in the Shape field when creating a parameter (which was mentioned above). There are two types of parameter scope.

Global scope

Parameters with global scope are applicable to all shapes, meaning they can be used in the formulas for any points in the section. To use global scope, select Global in the Shape field when creating the parameter. Global scope should be used when two separate shapes in the section must have the same dimensions. However, because there can only be one parameter with a given name in any scope it cannot be used when two shapes have separate parameters with the same name. For instance, if there are two I-

shapes then a depth parameter in global scope would ensure that the two I-shapes have the same depth. If they can have different depths, global scope should not be used.

Shape scope

Parameters with shape scope are applicable only within formulas for the points in that shape, or any of its cutouts or composite parts. To use shape scope, select the shape name in the Shape field when creating the parameter. Shape scope should be used when a parameter is meant to determine the dimensions of one shape in the section but not other shapes. Each shape can have its own set of parameters and will not conflict with parameters of the same name whose scope is another shape.

When parameterizing the tube section above, the scope of the three parameters was set to the Outer shape. This allowed the parameters to be used in the Outer shape, as well as within its cutout. If a new separate shape were added to the cross-section, such as a plate adjoined to the tube, the parameters would not be available to define the plate's points.

The Parameters spreadsheet in the Shapes Explorer shows all of the parameters available to the selected shape. If no shape is selected, only the parameters with global scope are shown. If an outer shape is selected, global parameters as well as parameters whose scope is that shape are shown. If a cutout or composite shape is selected, global parameters, the outer shape's parameters, and any parameters scoped to the cutout or composite shape are shown. When editing formulas in the Points spreadsheet, the list of available parameters is shown below the spreadsheet.

Formula Language

Formulas follow a simple and intuitive format. The following describes the formulas recognized by Section Composer.

Numbers: Numbers must be entered with a period for a decimal point. Commas separating thousands cannot be used. Engineering notation with an “e” followed by an exponent at the end of the number may be used. Examples: 10.25, 5280, 3.2e-1.

The standard arithmetic operators +, -, *, /, ^ (exponent) can be used and are interpreted with the standard order of operations. Parentheses can be used to group expressions. Example: $10 * 20 + (5/2)$

Special constants: Use “pi” as a stand-in for the value 3.14159... Example: $30*(\pi/180)$

Calling functions: The following functions are available: sqrt (square root), deg (convert radians to degrees), rad (convert degrees to radians), sin, cos, tan, atan (arc tangent), arcsin, arccos, and abs (absolute value). The trigonometric functions require their arguments to be given in radians, rather than degrees. Example: $\sin(\text{rad}(30))$

Parameters: Parameters used in formulas can have names only consisting of the letters a-z, upper or lower case. Parameter names are not case-sensitive, meaning “d” is the same as “D”. Examples: b, thickness.

Logical operators and the “iif” function: The “iif” function is used to evaluate one expression if something is true or another expression if something is false. This is best demonstrated by example. “iif(a <= 0, 0, a)” is a conditional expression that evaluates to the value of the parameter “a” if “a” is positive, otherwise it is zero. Conditional expressions can make use of the logical operators <=, >=, <, >, <> (not equal), =, AND, and OR. Example: $(a < 10) \text{ OR } (a = b)$

In nonprismatic sections, “x” has a special meaning. It represents the position along the span, either in absolute length units or as a fraction from 0 to 1, depending on the section settings. See Nonprismatic Variation (page 51).

Shape Templates

If you will be frequently reusing the same shape in many sections, it is possible to save a shape as a template so that it can be called up again in the **Insert Custom Shape** tool along with the pre-defined shapes that come with Section Composer. A shape template can be made out of a single shape (the selected shape) in the section.

When creating a shape template, it is important to define the shape's dimensions parametrically as we have here. In addition, the parameters must have shape scope, rather than global scope. Parameters with global scope will not be included in the template.

- ◆ To create a template, select the shape. Then in the **Shape** menu choose **Export As Shape Template...**. You will be prompted for a file name. Save the file in the directory where you are prompted. This is where Section Composer will look for user-created shape templates. You may need administrative privileges to save a shape template.

Reinforcement Bars

Reinforcement bars (rebars) provide tensile strength to concrete sections. The types and locations of rebars within sections can be entered in Section Composer and will be used in moment curvature and capacity analysis.

Rebars are entered in the Shapes Explorer in the Rebars tab.

- Start a new section and add a 20-by-10 inch horizontal rectangular custom shape. Then click the shape to make sure it is selected.
- Open the Rebars tab in the Shapes Explorer.

The left button in the rebars panel adds a new rebar into the selected shape. The rebar's shape, from a standard database, its material, and its coordinates must be entered. The coordinates are given in the shape local axes. Shape local axes differ from the member reference and local coordinate systems. Each shape has an arbitrary origin for its local axes. This is useful because the rebars will stay in the same location even if the shape is repositioned on the Section Composer canvas.

The shape local axes is indicated by dashed lines if **Shape Local Axes** are turned on in the **View** menu.

- Click the left button in the rebars panel to add a new rebar.
- Choose a standard rebar type in the first column and a standard steel material in the last column.
- Enter the coordinates for the rebar, relative to the shape's local origin. Put the rebar at the lower left of the shape, at $z=-8$ and $y=-4$.
- Repeat the process to put two more rebars at the bottom of the shape, at $z=0$ and $z=8$.

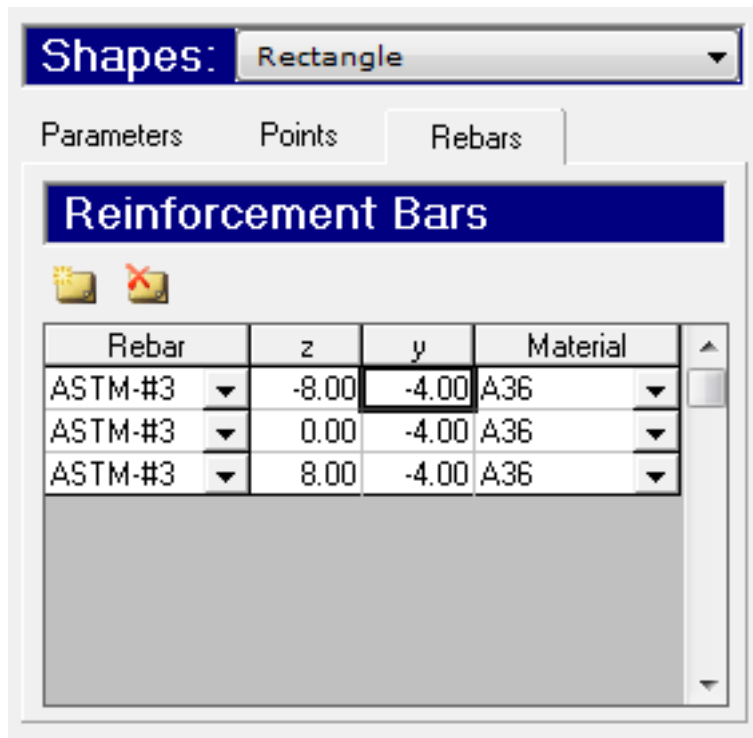

Rebar type, material, and locations are entered in the Rebars tab of the Shapes Explorer

The rebars are shown as grey circles on the drawing canvas.

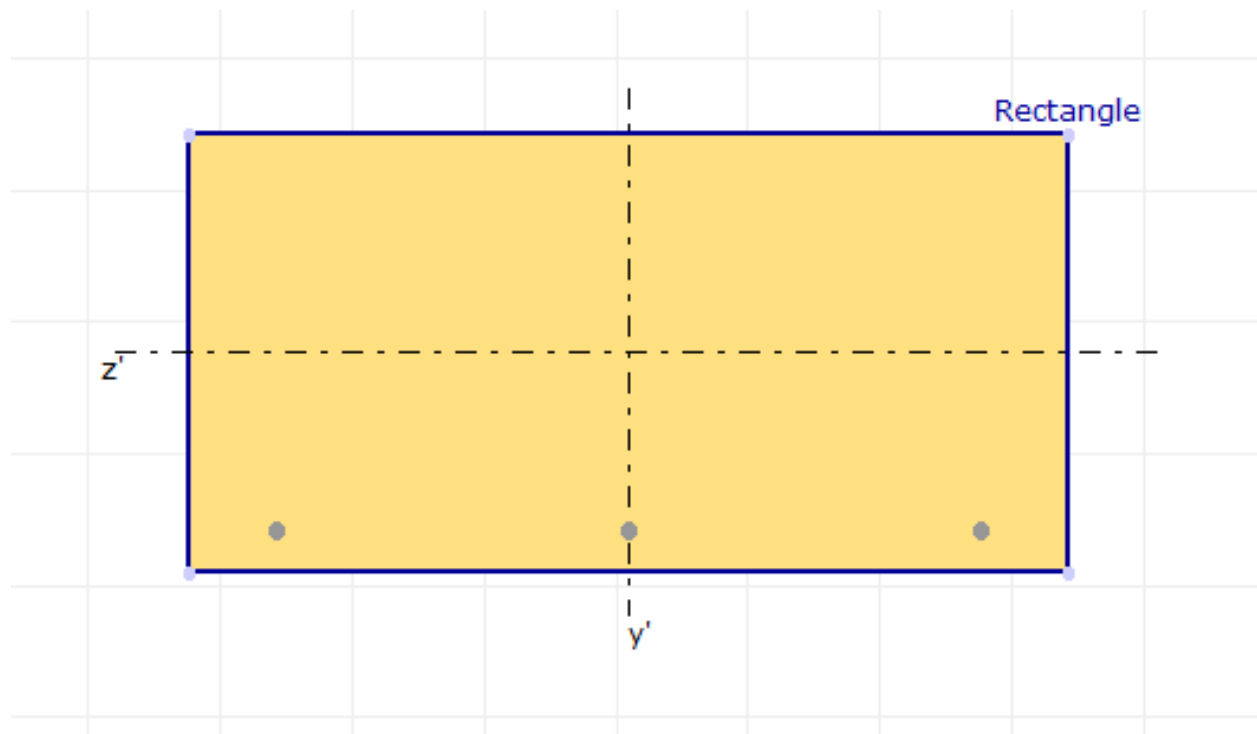

The rebars are shown in the drawing canvas

Because the rebar is of a different material than the rest of the section, it is necessary to tell Section Composer the material of the rectangle shape so that the cross-section properties can be computed. This is a similar process as to creating a composite shape (page 27). Use **Section** → **Composite Materials** to choose the concrete material for the rectangle shape. This becomes the reference material for the purposes of the computations. You must choose the same reference material as the material of the members that this section is assigned to in LARSA 4D.

Member Reference Line and Local Coordinate System

Each member element in a LARSA 4D model has its own local coordinate system. Having a local coordinate system simplifies the description of forces and moments on the member because they are more often parallel or perpendicular to the member than to the global axes. LARSA 4D and the Section Composer make use of a second member coordinate system, the reference coordinate system, also to simplify modeling.

Section Composer shows a two-dimensional cross-sectional picture of the section. The y-axis of the member is the vertical axis and the z-axis of the member is the horizontal axis. The (0, 0) coordinate at the intersection of the y- and z-axes on the canvas is at the *member reference line*. This is an x-axis that goes “into the screen.” The member reference line lines up with the line between the start and end joints of the member in the LARSA 4D model (assuming the member does not have member end offsets). We call these axes the *member reference axes*. The reference y-axis is displayed vertically (by default), matching the convention most often used for horizontal members, and the z-axis is displayed horizontally. If a different orientation angle is used, or if the member is not horizontal, care must be taken to understand how the reference axes displayed on the Section Composer canvas will be oriented around the member in the LARSA 4D model. The axes are highlighted in the figure below.

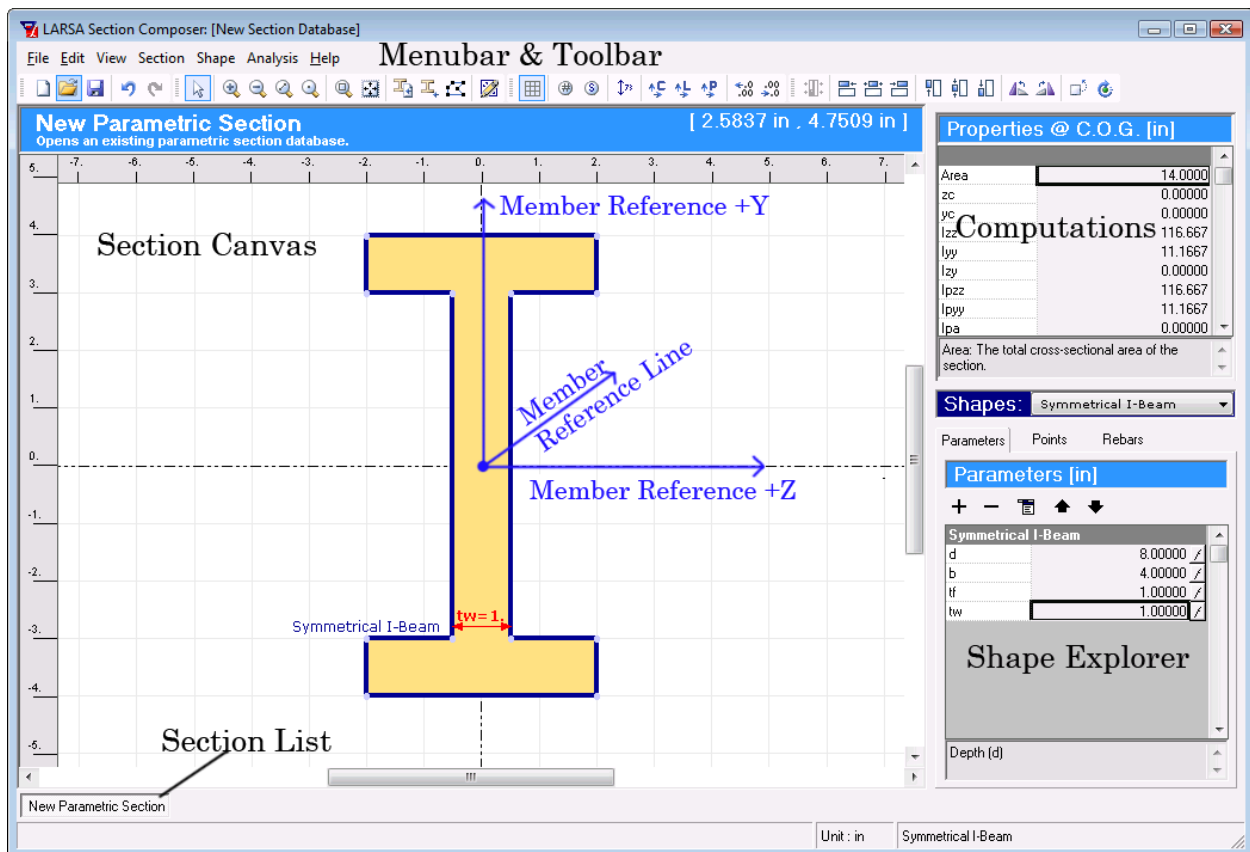

The member reference axes on the Section Composer canvas

The *centroid* of the section will not necessarily fall on the member reference line. If shapes are placed off center, LARSA 4D will assume the user wants the physical member offset from the member reference line, which can be convenient for aligning the section with a bridge centerline or modeling nonprismatic variation. In most cases, the user must take care to place shapes so that the section centroid falls on the (0, 0) coordinate in the Section Composer window. When the section reference line and centroid do not coincide, the reference axes serves as the origin for geometry including the alignment of the section while the centroid serves as the origin of the member “local coordinate system” which is used for loads and results.

The two systems are the **reference coordinate system** and the **local coordinate system**. In most cases, the two systems are the same. They differ only when a member has been assigned a section created in Section Composer with a centroid that is offset from the reference coordinate system.

Reference Coordinate Systems

The member reference coordinate system is used for the alignment of structure geometry. It determines how the cross-section is placed relative to the member element, and it is also used for the placement of tendons [see “Tendons” in *LARSA 4D Reference Manual*] within members and lanes [see “Lanes” in *LARSA 4D Reference Manual*] when they have offsets. The x-axis of this coordinate system runs from the start of the member, meaning the start joint plus any member end offsets applied to the start of the member to the end joint plus any end offsets at the end of the member. The member reference line point on the Section Composer canvas represents this x-axis, and so the locations of shapes relative to this point determine how the section lines up in the LARSA 4D model.

The location of the reference coordinate system is depicted in the figure below. The start (I) and end (J) joints of a member are depicted as blue spheres. If there are no member end offsets (left), the reference x-axis, also called the reference line, runs from the start to the end joint. If there are member end offsets (right), the reference line is shifted accordingly.

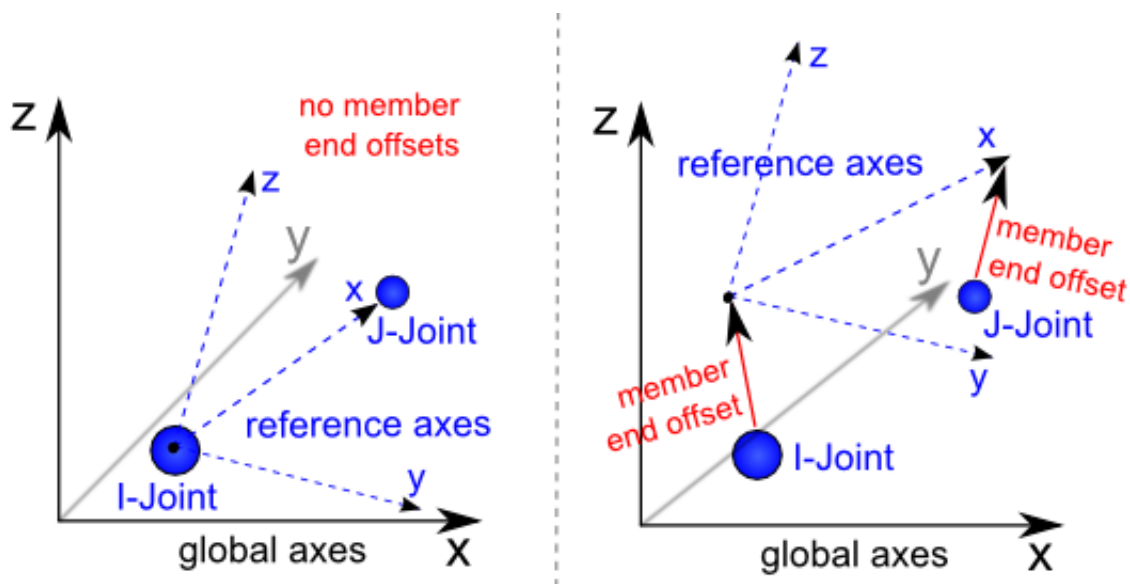

Member Reference Axes - Alignment With Joints

The y- and z-axes of the reference coordinate system are perpendicular to the reference line and are oriented in the LARSA 4D model according to the orientation angle of the member. The convention for orienting these axes is described in detail in Members [in *LARSA 4D Reference Manual*]. For horizontal members, generally a 90-degree

orientation angle is used so that the member reference z-axis points horizontally. In that case, the member reference z-axis should be parallel to the section's flanges, if applicable.

Positioning the Section

When creating a section, the user has the freedom to place the shapes anywhere relative to the reference axes. As a result, the section centroid may not coincide with the member reference line. While in most cases the section centroid does line up with the reference line, offsetting the centroid can be useful in several cases. In the case of a cross-section representing a bridge deck, the alignment of the cross-section with the structure geometry is made at a special centerline reference point on the surface of the deck. In that case, the cross-section would be positioned so that the top surface of the section aligns with the reference z-axis, putting the centroid not on the reference line but below. This is depicted in the figure below. Recall that the joints are positioned on the reference x-axis.

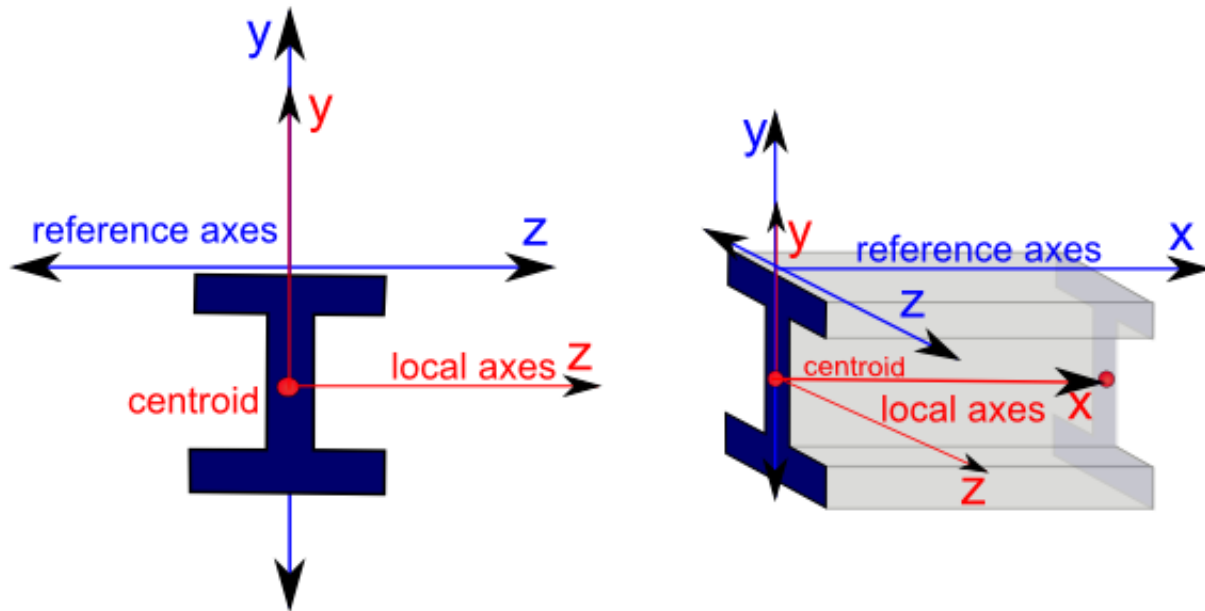

Member Reference and Local Axes - With A Centroid Offset

If the section has nonprismatic variation, it is especially helpful to align the cross-section at the point on the section that is not varying. If the section varies in depth, then it is useful to align the section with the model at the section's top, which has constant elevation.

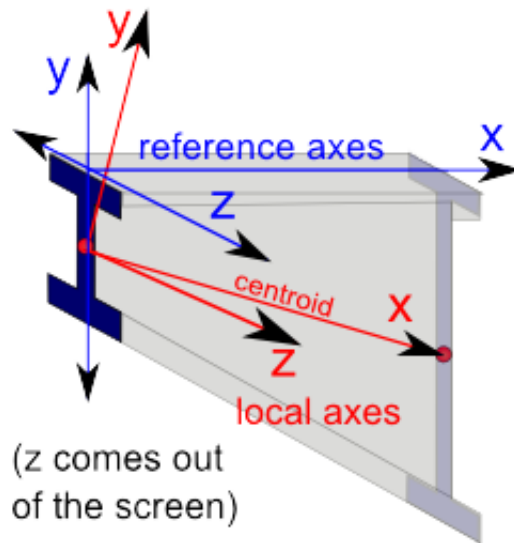

Member Reference and Local Axes - Nonprismatic Variation

In the figure above, the joints are located on the member reference x-axis (reference line). The I-shape is created in Section Composer such that its top surface is flush with the member reference z-axis. The centroid is below the reference line. When this section is applied to the LARSA 4D model, the centroid of the member will be automatically offset from the joint-to-joint line. In fact, the centroid will automatically follow the haunch of the section with the top face of the section held at constant elevation.

LARSA 4D displays members as their centroid lines, rather than at the member reference line. The figure below shows how LARSA 4D displays a member nonprismatic cross-section variation in depth. The members are strung across the joints; however, the centroid falls below the joints and this is where the members are drawn.



In LARSA 4D, members are displayed as their centroid lines, indicating centroid offsets from joints

When LARSA 4D's complete rendering is turned on it is easy to verify that the section is positioned correctly relative to the joints.

Local Coordinate System

The member local coordinate system is always placed at the member centroid. This is the system in which the section I_{yy} and I_{zz} properties (page 25) are given and the system in which member loads [see "Member Loads" in *LARSA 4D Reference Manual*] and results such as end forces [see "Member End Forces" in *LARSA 4D Reference Manual*], sectional forces [see "Member Sectional Forces" in *LARSA 4D Reference Manual*], end stresses [see "Member

Stresses” in *LARSA 4D Reference Manual*], span deflections [see “Member Displacements” in *LARSA 4D Reference Manual*], and analyzed loads [see “Analyzed Member Loads” in *LARSA 4D Reference Manual*] are specified. If the section centroid is at the member reference line, which is always the case for sections from a standard database, then the member reference and local coordinate systems are identical. Otherwise, the member local coordinate system will be different.

The member local coordinate system x-axis corresponds to the line of the member centroid from the start of the member to the end.

If the section does not have nonprismatic variation, then the local axes are merely a translation of the reference axes from the reference line to the centroid. The local y- and z-axes are thus oriented at the centroid so that they are parallel to the y- and z- reference axes, respectively. This can be seen in the figure above without nonprismatic variation. Note that the local member axes are then not necessarily principal axes since the section could have been placed arbitrarily on the drawing canvas. Only if the product of inertia I_{yz} is zero will the local axes coincide with the principal axes. The user is responsible for orienting the section so that the principal axes line up with the reference/local axes if that is desired.

If the section has nonprismatic variation, the local coordinate system y- and z-axes are positioned slightly differently so that they are perpendicular to the local coordinate system x-axis. The local axes are positioned by first translating the reference axes to the centroid at start and then rotating them so that the x-axis passes through the location of the centroid at the end of the member. This can be seen in the figure above with nonprismatic variation.

If the centroid of the section does not meet the member reference line as we have been discussing, LARSA 4D will apply the necessary rigid offsets from the joint to the centroid, similar to member end offsets [see “Members” in *LARSA 4D Reference Manual*], to the members in order to ensure that the model is analyzed properly. Because member end offsets are specified in global coordinate system directions, they are not convenient for specifying a centroid offset from the reference axes.

For More Information, please refer to the following documentation.

- Members in *LARSA 4D Reference Manual*.

Nonprismatic Variation

Nonprismatic variation is the variation of section dimensions along the length of a member. It is created in Section Composer by applying formulas to shape parameters.

Recall that shapes can be defined through parameters such as d , b , tf , and tw for the I-shape. Normally the parameters are given numeric values, i.e. 25 inches. To set up nonprismatic variation, the parameters are given as formulas in terms of the special x variable. This variable represents the position along the length of a span. If an I-shape varies in depth, the d parameter might be set to $10 + x*15$. This might represent a depth of 10 inches at member start ($x=0$) and 25 inches at member end ($x=1$), which a linear slope in between. Any formula supported by the formula language (page 35) can be used.

Because the physical dimensions of nonprismatic sections vary along the length of the span, so do the sectional properties of the span. The LARSA 4D analysis engine and the stress reports will take into account nonprismatic variation when a nonprismatic section is assigned to members [see “Members” in *LARSA 4D Reference Manual*] or spans [see “Spans” in *LARSA 4D Reference Manual*] in a project. It may be necessary to create spans depending on the setup of the variation.

Starting an Example

To begin the example in this section, start a new Section Composer section. Add an I-shape using the **Insert Custom Shape...** tool. It must be a custom I-shape, and not a standard I-shape, so that the dimensions can be modified by applying a formula.

The x Variable

The special x variable gives the position along the length of the span in one of two ways. The variable may be in absolute linear dimensions, e.g. feet or meters, from the start of the span. The unit of length depends on the unit chosen for the section in the **Units** window in the **Section** menu. Alternatively, the x variable may be a value from 0.0 to 1.0, where 0.0 is the start of the span and 1.0 is the end of the span. This is called relative position, because it is relative to span length, which might not be known ahead of time or might vary from span to span.

- ☛ To choose the type of x variable to use, open the **Nonprismatic Variation** window from the **Section** menu. The choice is at the top right. In this case, we will leave the choice as Relative Span Position. Close the nonprismatic variation window.

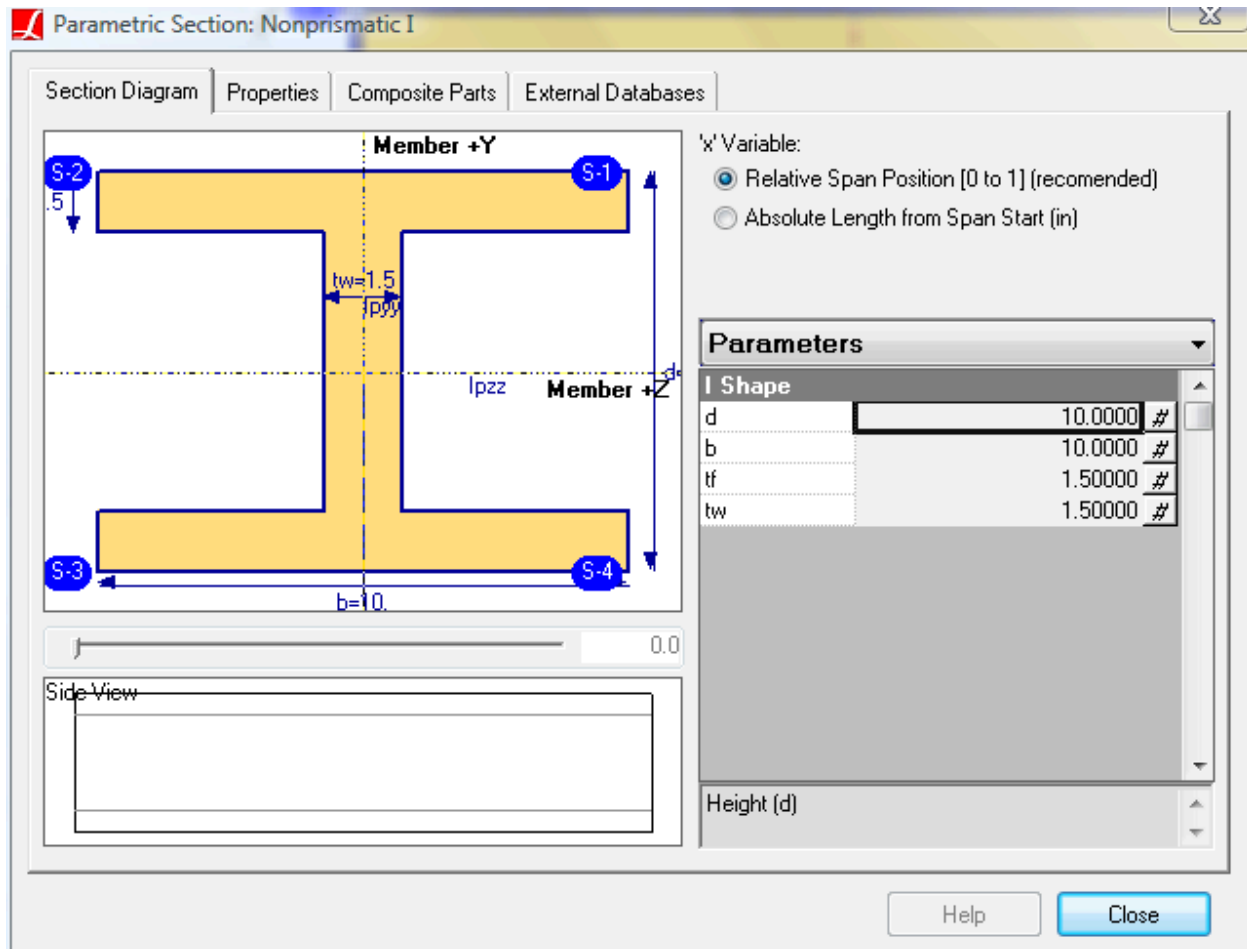

Setting the 'x' Variable Type

For both settings, the 0.0 value for x always corresponds to the location of the start joint of the first member in a span.

We will make this I-shape vary in depth. First, notice how the I-shape has been designed when the depth parameter varies.

- Change the value of the depth parameter d a few times.

Notice how the top edge of the section remains in place while the bottom edge changes. It has been set up this way, rather than keeping the shape centered, for the benefit of nonprismatic variation. In actual models, it is more likely that the top surface of the member will lie flat while the lower surface moves, rather than the member growing taller or shorter in both directions simultaneously.

To make this section nonprismatic, we will replace the value for the d parameter (currently 10) with a formula in terms of the x variable.

- To apply formulas to parameters, make sure the *Parameters* tab is active in the Shapes Explorer at the lower-right corner of the Section Composer screen. Click the shape to activate it, and then find the appropriate parameter back in the Shapes Explorer that will have variation.

The simplest formula will be to give it linear variation between 10 and 25. This formula is $10 + x*15$. When $x=0$ at the span start, the formula has the value of 10, so the depth will be 10. At the span end, where $x=1$, the formula has the value 25. The depth will vary linearly in between.

- ☛ Replace the numeric value with the formula.

Nothing changes on the Section Composer canvas. Because it is a 2D representation of the section, the variation is into the screen and cannot be seen. The Section Composer canvas always shows the cross-section properties at the start of the span.

- ☛ Return to the **Nonprismatic Variation** window in the **Section** menu to preview the variation.

A preview of the variation from a side view is displayed at the bottom of the window. The cross-section image at the top left can show the section shape at any point along the span. Drag the slider below the image to move to a different point on the span.

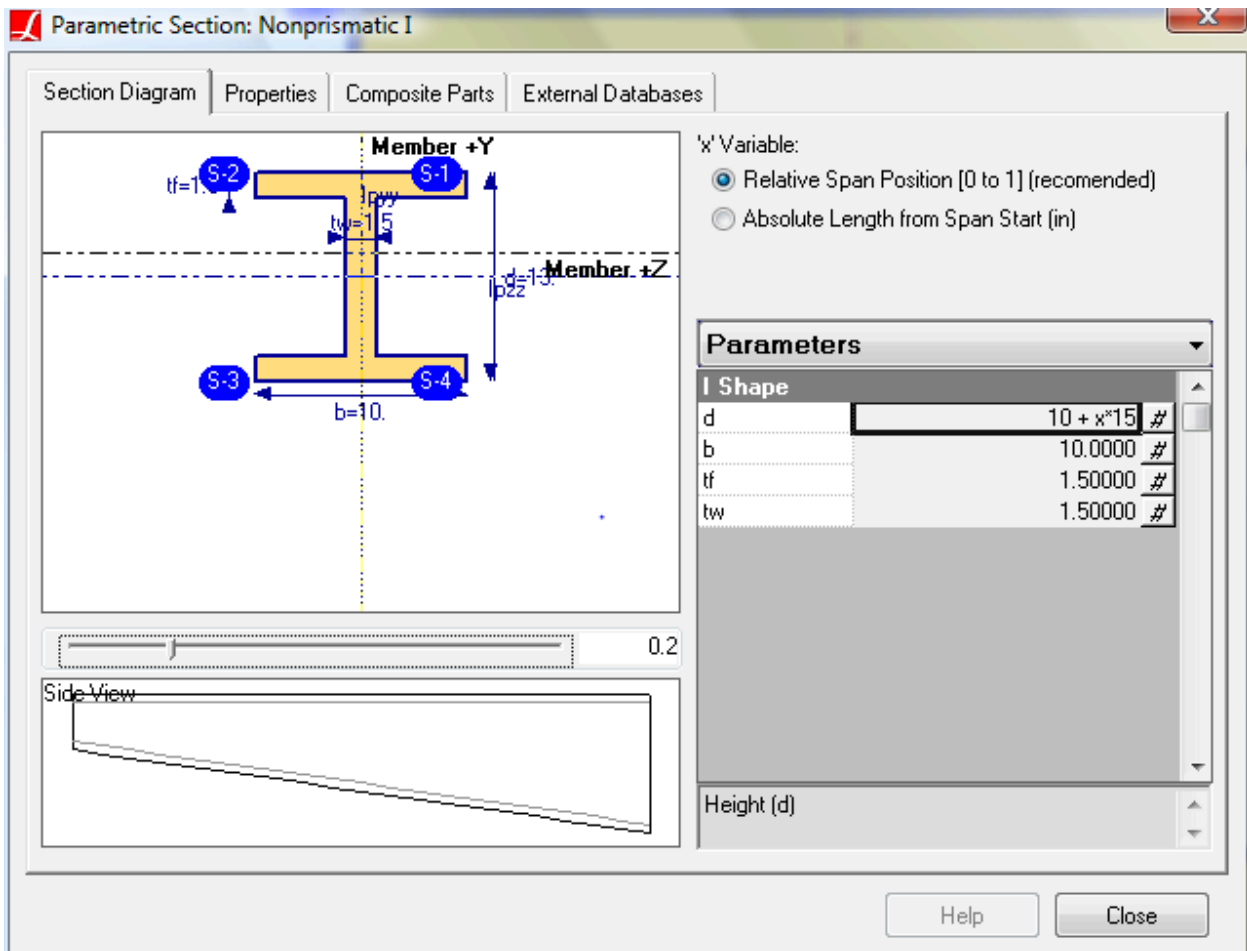

Previewing nonprismatic variation

Formula Helper

When the x variable is in absolute length units, another useful formula might be $5 + x/12$ which would vary depth starting at 5 units and linearly increasing at a slope of 1:12.

The formula $10 + x^2/32$ creates parabolic variation.

To save time when devising formulas, Section Composer has a formula helper. On the Parameters spreadsheet there is a small “P” button to the right of each value or equation. Clicking this button opens the formula helper, which can be used to create formulas for several common situation: linear variation, parabolic variation, and sinusoidal curves. The formula helper is shown in the figure.

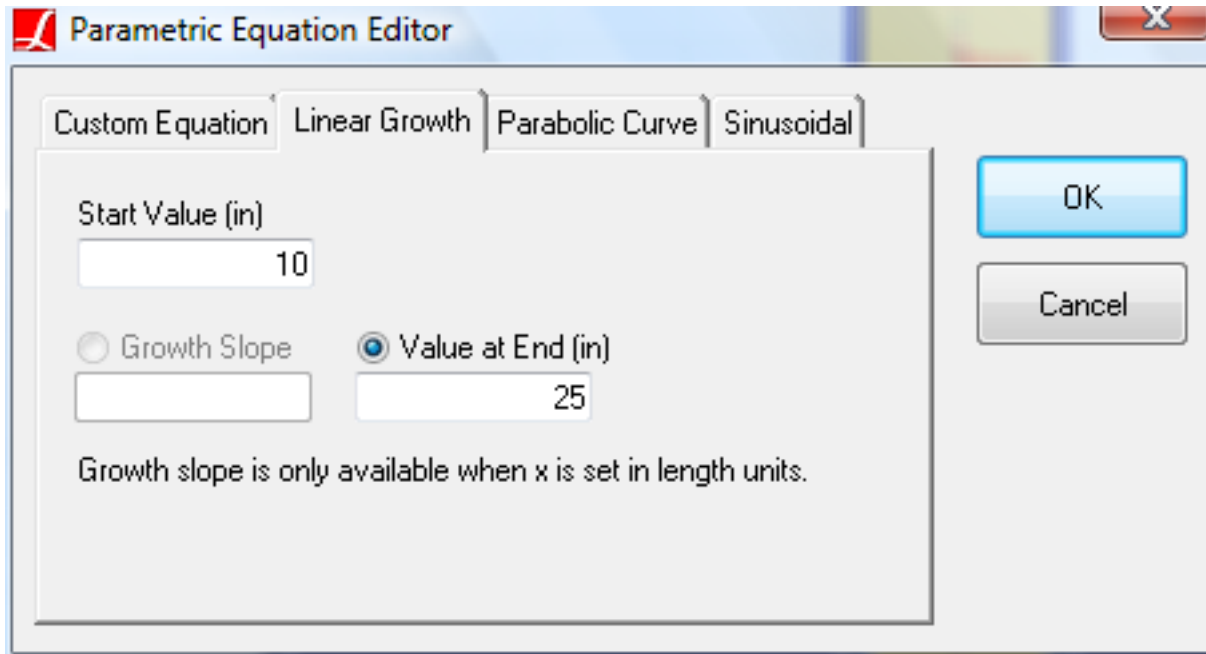

Formula helper

- Click the “f” button beside the d parameter.

The formula helper opens to the linear variation tab filling in the fields as determined by the equation we had previously entered by hand. This tool allows the user to enter the start and end values of depth, rather than creating a formula by hand. If we had not entered a formula, you could enter the values here and it would create the formula.

- Revise the formula and then click OK. Notice how the parameters spreadsheet updates with a new formula.

Positioning the Centroid

We have the non-prismatic variation defined; however, there is one issue to be noted before we move on. Normally, members in LARSA 4D are positioned where their centroids are. In other words, the centroid of the member is what is modeled in LARSA 4D as the joint-to-joint line. Or, member end offsets are used to specify that the member centroid is at a different location from the joint-to-joint-line. Since this section has nonprismatic variation, its centroid is moving as you go down the span. That would mean that, in LARSA 4D, we would need to adjust either the joint locations or the member end offsets at the start and end of each member in order to locate the centroid in the LARSA 4D model at each of these positions. This would be a tedious task.

Thankfully, this is not necessary because we can align any part of the section with the joint-to-joint line, not just the centroid, by positioning the section properly relative to the member reference line (page 45). In this case, we want the top edge of the section to align with the member reference line. This way, if the members in LARSA 4D are creating

with joints on a straight line the top of the girder will stay flat while the centroid and bottom edges move according to the nonprismatic variation.

If the centroid of the section does not meet the section reference line, LARSA 4D will apply the necessary rigid offsets from the joints to the centroid in order to ensure that the model is analyzed properly.

- ☛ If it is not already selected, select the I-shape by clicking on it.
- ☛ Use the Align Top tool in the toolbar to align the top edge of the shape with the member reference z-axis.

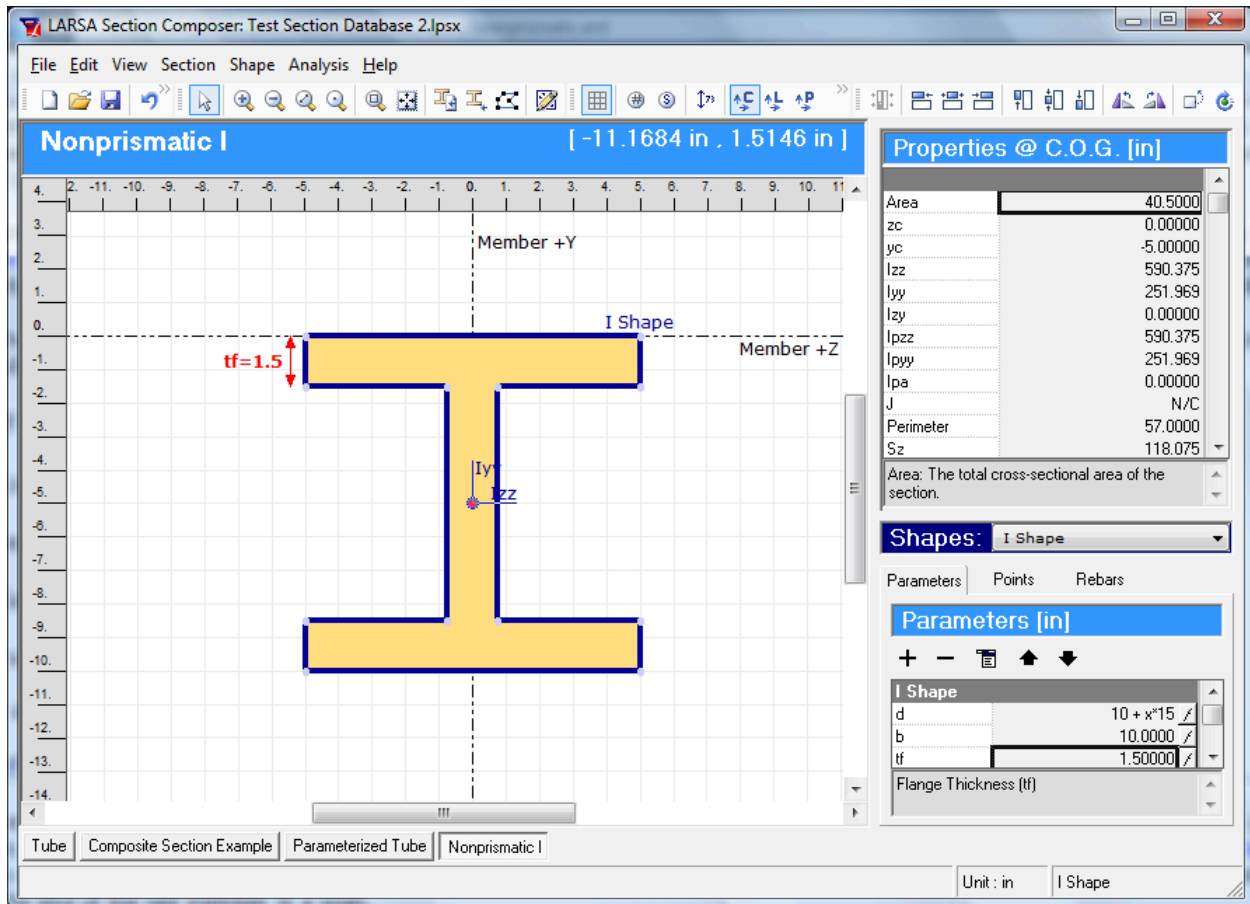

The I-shape's top edge is aligned with the member reference z-axis

When modeling this girder in LARSA 4D, the members should be positioned at the top of the section.

- ☛ Save the database. Then open LARSA 4D and attach the database to the project.
- ☛ Create a member 10 feet long. Assign the section to the member and give it an orientation angle of 90 degrees.
- ☛ Use **Graphics** → **Complete Rendering** to view the physical section.

Notice how the section is aligned as intended with the top face of the section on the member reference line, i.e. the joint-to-joint line, with the depth varying below.

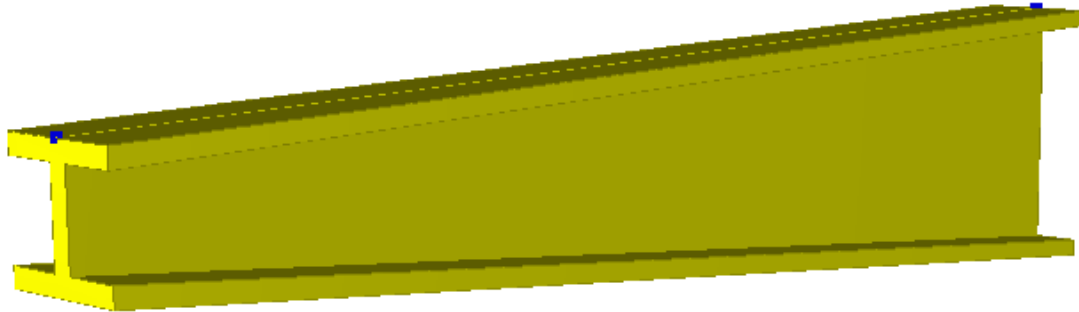

The nonprismatic section applied to a member in LARSA 4D

Although members have Section At Start and Section At End fields, only Section At Start is used for sections defined with nonprismatic variation using Section Composer. Section At End is an alternative method to create nonprismatic variation from two separate sections of similar shape but different dimensions.

Multi-Member Spans

When a section with nonprismatic variation is initially assigned to a member, the variation runs from the start of the member to the end of the member only. Each member will be treated separately, and the x variable resets at the end of each member. This is usually not what is desired, as often many so-called analytical members are used to model a single physical member.

- ☛ Use **Break Members** in the **Modify** menu to break the member into six pieces.

The result clearly needs some work.

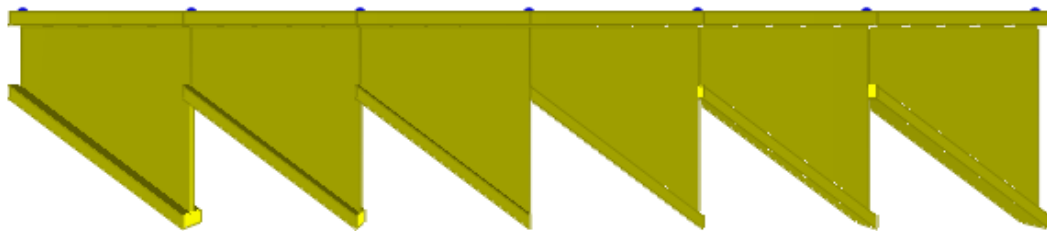

After breaking the member, a span needs to be defined

When multiple analytical members make up a single physical member, LARSA 4D calls it a span [see “Spans” in *LARSA 4D Reference Manual*]. Spans have several uses in LARSA 4D. One is to indicate that nonprismatic variation

is to continue smoothly from the start of the span to the end. The x variable does not reset at the ends of members within spans. When using relative units, 1.0 corresponds to the end of the last member in the span.

To create the span, we will want to have only the members on the span selected. This is already the case. But for pedagogical purposes we will assume the model is more complicated.

- ☛ Unselect everything in the project. (Use **Selection** → **Unselect Objects** → **Unselect All**, or any of the alternatives.)
- ☛ Using the Pointer mouse tool, right-click any of the members.
- ☛ Choose **Select Chain**. This tool selects all of the members running up and down the model from the one that was clicked.
- ☛ Go to **Draw** → **From Selected Members** → **Span**.

The nonprismatic variation is revised to go smoothly across the span.

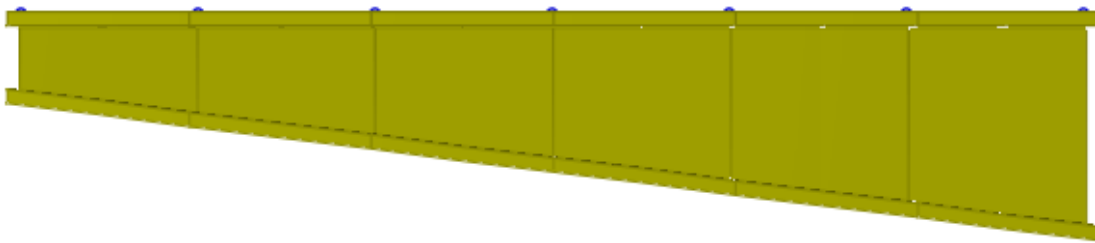

After creating a span, the nonprismatic variation is applied as intended

Spans are visible in the graphics window if the option is turned on in **Graphics** → **Show**. There is also a spreadsheet for spans in the geometry group in the members tab.

- ☛ Turn off complete rendering. In the figure the span is depicted as the thick green line. The members are depicted as the yellow line at the member centroid.

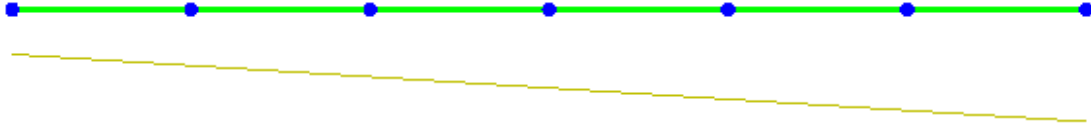

When complete rendering is off, members are shown at their centroids

Analysis of nonprismatic sections

The beam-column element used in the LARSA 4D analysis has constant section properties throughout. When a member has nonprismatic variation, the nonprismatic variation must be approximated: member properties are taken at the midpoint of the member and are assumed to apply throughout. As a result, members with nonprismatic variation should be sufficiently broken down into smaller pieces so that the variation within each member is negligible for the purpose of analysis.

While member force results reflect this simplification, member stresses are computed at stress recovery point locations that follow the nonprismatic variation defined in Section Composer. That is, the locations of stress recovery points are taken according to the parameter formulas applied at the start or end of the member, not at the midpoint.

For More Information, please refer to the following documentation.

- Members in *LARSA 4D Reference Manual*.
- Spans in *LARSA 4D Reference Manual*.

Composite Material Sections

Sections composed of parts of different material properties can be created in Section Composer. Starting with LARSA 4D version 8.0, these sections account for the differential effects of self-weight, thermal loads, and time-dependent material effects, and stresses can be reported in each material part.

A composite material section is a section composed of shapes that have different material properties (see Free Shapes, Cutouts, and Composite Shapes (page 27)) or a shape plus rebars (page 41). In composite sections, the overall section properties depend on the materials of the parts, and the forces and stresses in each shape may be different from that in other shapes.

While in non-composite sections the material of the section is not specified in the Section Composer (instead a material [see “Materials” in *LARSA 4D Reference Manual*] is assigned to the member [see “Members” in *LARSA 4D Reference Manual*] in LARSA 4D as is usually done), to make a composite section use **Section** → **Composite Materials** to choose a material for each shape. A reference material must be chosen at the top of the Properties Explorer so that the section properties (page 25) can be computed.

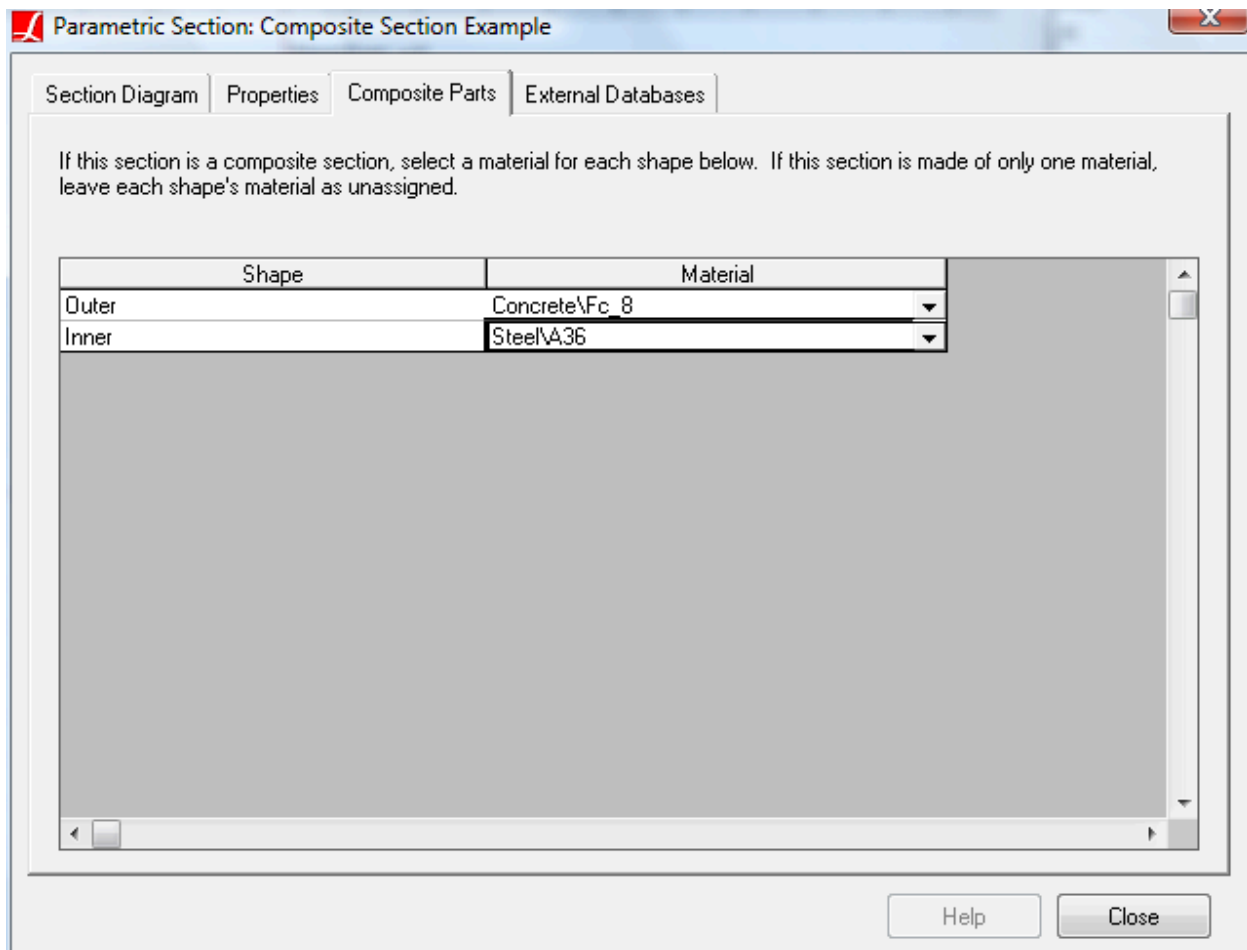

Choosing materials for a composite material section

If a material is chosen for any component shape or if any shape has rebars, then a material must be chosen for all component shapes and a reference material must be chosen.

In LARSA 4D version 7 and earlier, the material assigned to members of a composite section must be the same as the Reference Material set in the section definition. In LARSA 4D version 8 and later, a material *must not* be set on members who have been assigned a composite material section. This change is intended to guarantee the consistency of model input. While the Reference Material is necessary to compute section properties such as I_{yy} and I_{zz} , the choice of Reference Material is irrelevant for the final analysis because only combined material-section values such as $E \cdot I_{yy}$ are needed, which come out the same for any choice of Reference Material.

Composite Construction Sections

In LARSA 4D version 8's Staged Construction Analysis, it is possible to construct individual component shapes of sections, such as in casting additional concrete sections onto what is treated as a single cross-section.

A composite construction section is a section composed of multiple shapes that are assembled at different points in time during a Staged Construction Analysis [in *LARSA 4D Reference Manual*]. In composite sections, the overall section properties depend on the materials of the parts and set of shapes that are "active" at each point in time. Additionally, the forces or stresses in each shape may be different from that in other shapes.

In Staged Construction Analysis [in *LARSA 4D Reference Manual*], different component shapes of a composite section can be constructed at different times by using the Composite Section Construction Activities [in *LARSA 4D Reference Manual*]. The Section Composer and LARSA 4D have been designed so that different members in a model can use the same section definition but component parts can be constructed at different times. That is, a single section created in the Section Composer can have different construction sequences depending on the member it is assigned to. As a result, the precise time at which shapes in a section are constructed is *not* set in the Section Composer.

Rather than setting the times of construction of component shapes, instead various "construction sequence states" are set. Each state is a configuration of component shapes that are either active or inactive at any given time.

Construction Sequence

If the section will be used in Staged Construction Analysis and if it will be assembled in parts, the sequence of assembly of the parts of the section must be set. The Construction Sequence Explorer in Section Composer is used to create *construction states*. A construction state represents one possible state that the section may be in during its construction.

As an example, consider a section consisting of two shapes, an I-shape and a flange shape. The I-shape is steel and the flange shape is concrete. In the Staged Construction Analysis model, the model will be constructed in four steps:

1. Constructing piers and other structural elements unrelated to this section.
2. Placing the steel I-shape into the model.
3. Pouring the concrete flange shape so that it contributes weight but no stiffness.
4. And then considering the concrete flange set and load-bearing.

So that, the section will have three states:

1. In the first state, only the I-shape is present.
2. In the second state, both shapes are present with the flange shape is set to *Weight Only*.
3. In the third state, both shapes are present with their weight and stiffness.

Note here that there is no need for a construction sequence state that does not include the steel I-shape: When no shape is active, the member element should not be included in the model at all.

The states are created by following the below steps:

- ☛ Activate the Construction Sequence Explorer by clicking the *Const. Seq.* tab of the section explorer.
- ☛ Click the **Add State** button three times to add the states. The first state is always considered the initial state of the section.

When a state is clicked, the shapes that are not activated in that state are shown unshaded, to indicate they are not active.

- Add the I-shape into the first state by first clicking *State A*. Then select the I-shape by clicking it in the main drawing area.
- Last, click the **Add Shape** button to activate that shape in *State A*.
- Repeat the process for *State B* and *State C* to indicate the shape is still active in that state.
- Then repeat the process to add the concrete flange shape into *State B* and *State C*.
- In order to set the flange shape to *Weight Only* in *State B*, use the **W/S** button.

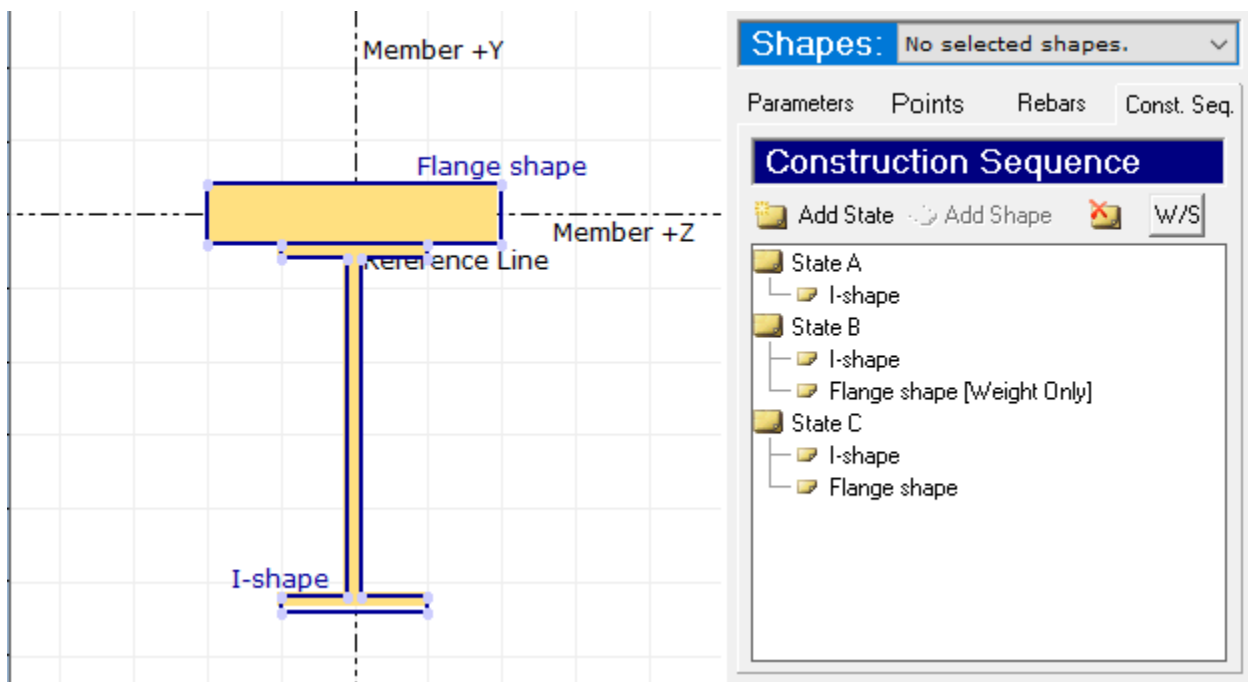

Construction Sequence States

Note that because the casting-day and weight-only characteristics of this section apply to a single shape only, and not the whole section, the casting day option on members [see “Members” in *LARSA 4D Reference Manual*] and the weight-only option for constructing structure groups [see “Setting Up the Model” in *LARSA 4D Reference Manual*] are not used for this purpose. Instead, construction sequence states, including a state with *Weight Only* property, are created for this section in the Section Composer and the times at which the states are used are set later as Composite Section Construction Activities [in *LARSA 4D Reference Manual*] in LARSA 4D. Also, the Cast Concrete Activities [in *LARSA 4D Reference Manual*] is used to set the casting day of concrete flange shape.

Section Analysis

Several section analysis tools are provided in Section Composer and LARSA 4D: Moment Curvature and Yield Surface computation, Ultimate Strength Check, and Moment Curvature Analysis.

Ultimate Strength Check

The Ultimate Strength Check tool allows users to compute flexural strength (also known as moment capacity) on prestressed and/or reinforced concrete or steel structures. Currently, the tool has support for the following codes: AASHTO LRFD 2006, BS5400, and EN 1992-1-1:2004.

The ultimate strength check computes the flexural strength for the section taking into account the placement of reinforcement bars within the section and, if run from LARSA 4D, post-tensioning tendons running through the section and either their short-term or long-term forces.

The tool is described in Ultimate Strength Check [in *LARSA 4D User's Manual*].

Moment Curvature Analysis

The Moment Curvature Analysis tool allows users to perform moment curvature analysis on cross-sections, capable of taking prestressing/post tensioning and reinforcements into account. Currently, the tool has support for the following codes: AASHTO LRFD 2006, BS5400, and EN 1992-1-1:2004.

The moment curvature analysis takes into account the placement of reinforcement bars within the section and, if run from LARSA 4D, post-tensioning tendons running through the section and either their short-term or long-term forces.

The tool is described in Moment Curvature Analysis (Legacy Tool) [in *LARSA 4D User's Manual*].

Moment Curvature and Yield Surface

To view the moment-curvature diagram or yield surfaces for a section based on a simple computation procedure, use **Moment Curvature and Yield Surface** from the **Section** menu. (The moment curvature tool described above is a more advanced analysis option.) Choose either Y or Z axis moment. Enter the appropriate maximum curvature and extreme fiber strain values. If the section is not composite, choose the section's material. Finally, to evaluate moment-curvature at multiple values of axial force, enter the axial force increment to use and the number of axial force steps to take.

Switch between the Moment Curvature and Yield Surface tabs to see the two diagrams.

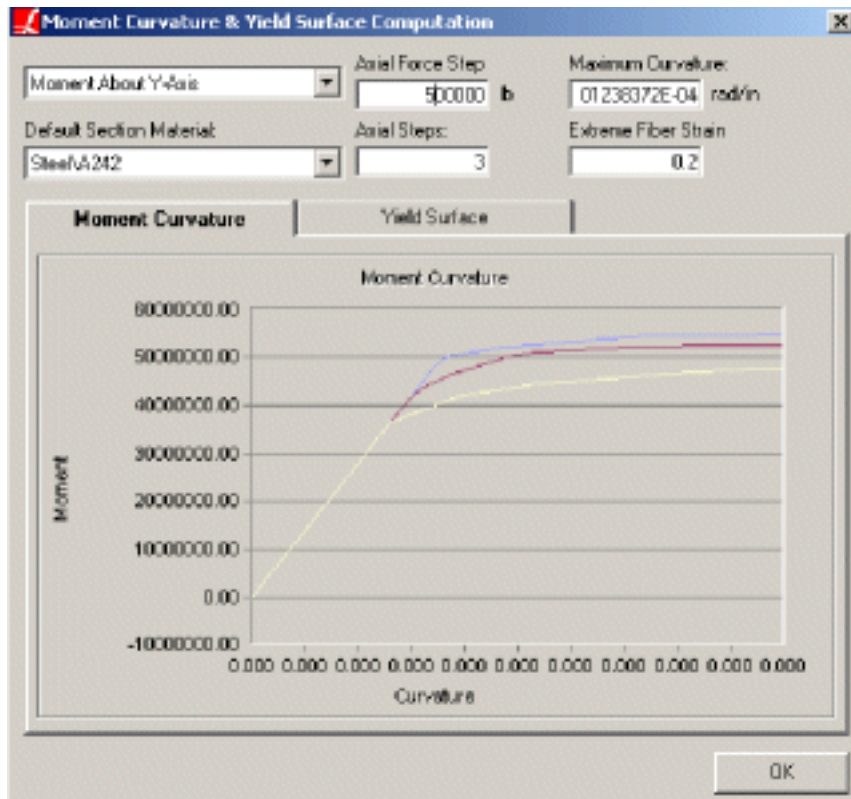

Moment Curvature computation

This tool does not take into account the presence of rebars in the section.

Glossary

Shape

The shape is the basic component that can be used to create sections. The properties of individual shapes are determined automatically based on its dimensions and material properties. Shapes can be inserted from the parametric shape library, from standard databases, or created as user-drawn arbitrary shapes. The parametric shape library contains over fifty predefined parametric shapes including simple predefined shapes such as I, C, T, L and Box as well as complicated shapes like box girders. You can also draw any arbitrary shapes by using free draw tool.

Shapes are generally given names, such as "Rectangle", "Cutout", "Flange", or "Web".

The dimensions of shapes are set either through coordinates or parameters such as `d`, `b`, `tf`, and `tw` for I-shapes (depth, width, flange thickness, and web thickness). The values of parameters can be numbers or equations such as `sqrt(2)*5`. Equations are used especially for defining nonprismatic variation, changes in the shape of a section *along the length* of a span, but also can be used to create a parametric shape definition.

When a section requires shapes not found in the standard tables or in the parametric shape library, they may be modeled as user-drawn arbitrary shapes. The Section Composer is able to automatically compute the properties of arbitrary shapes, no matter what the shape.

Section

A section is a collection of one or more shapes. Sections are given names and are stored in section databases. All of the shapes in a section must be touching (see the torsion constant computation later in this manual).

All of the properties of a section needed for an analysis are computed by the Section Composer.

Section Database (.lpsx file)

A section database is a file with the `lpsx` extension which contains section definitions. These files are edited using the Section Composer and can be linked to a LARSA 4D project in LARSA 4D using the Connecting Databases [in *LARSA 4D User's Manual*] command. A section database may contain more than one section as a convenience, so that all of the sections relevant for a project can be saved within a single file. However, updating a section in a section database will affect all LARSA 4D projects that make use of the database.

Standard Shape

Standard shapes are those which come from a standard table, such as AISC or EURO. Many section tables are available in Section Composer. The properties of standard shapes cannot be modified in Section Composer: their dimensions and properties are guaranteed to be exactly what is found in the original section table. Because these shapes are fixed, they cannot be used for creating nonprismatic sections.

Parametric Shape

Section Composer derives most of its power from parametric shapes. These shapes, which come in a variety of flavors, are dimensioned using parameters, not points. Whereas an I-shape has 12 vertices, it only has 4 parameters: `d`, `b`, `t`, and `w`. Only those parameters need to be set in Section Composer for it to be able to calculate all of the shape's properties and to display it graphically.

In addition, parametric shapes may be given nonprismatic variation by assigning equations of variation to each parameter using a special x variable.

Parameter

A parameter is a named value that can be referenced in equations for the locations of points. The coordinate of a point might be, for instance, $(-b/2, -d/2)$ for the lower-left coordinate of a rectangle shape, where b and d are parameters.

Cutout Shape

Shapes are generally solid. In order to create a shape with a hole, such as for a tube or box girder, a second shape called a cutout must be placed inside the outer shape. The cutout defines the inside perimeter of the shape. Multiple cutouts can be placed in the same shape, such as for multiple-cell box girders.

Composite Shape

Shapes are generally made of the same material throughout. Composite shapes are placed within other shapes to indicate a change of material within the shape. If a section has two independent parts of different material, composite shapes are not necessary. A composite shape is necessary only when one material completely encloses another.

Member Reference Line

The member reference line is the joint-to-joint line of a member (plus any member end offsets set in LARSA 4D). This is a reference point that determines how shapes placed on the Section Composer canvas line up with the member element in LARSA 4D. Normally shapes are positioned by the user so that the computed section centroid lines up with the member reference line.

Member Reference Axes

The member reference axes are the $x/y/z$ axes that determine how a Section Composer section lines up with the member element in LARSA 4D. The member reference x -axis is the same as the member reference line. The member reference y - and z -axes are perpendicular to the reference x -axis. Their orientation in LARSA 4D is determined by the member orientation angle. By convention the web of a section is parallel to the member reference y axis, which corresponds to an orientation angle of 90 degrees in LARSA 4D. Note that the reference axes do not necessarily correspond to the section's principal axes but often do.

Member Local Coordinate System

If the section's centroid is placed at the member reference line, then the member reference axes also correspond to the member local coordinate system. The member reference axes are used for the placement of lanes and tendons in the model, while the local coordinate system is used for forces (but loads and results). If the section centroid does not line up with the member reference line, the member local coordinate system's origin is at the centroid with y - and z -axes parallel to the reference axes. Note that the local coordinate system does not necessarily correspond to the section's principal axes if the section is asymmetric.

Nonprismatic Section

Normally a member has the same dimensions along its entire length: it is a prism. Members may vary in depth, width, or in any other dimension along their length. Such members are said to have nonprismatic sections. The analytic properties of nonprismatic sections also vary along the length of the member. Varying dimensions and properties are taken into account in LARSA 4D when modeled in the Section Composer.

Composite Material Sections

Sections may be made of a composition of multiple shapes, each having a different material. Such sections are called composite material sections. Section Composer will take the composite nature of a section into account when calculating section properties.

The differential effects of self-weight, thermal loads, and time-dependent material effects on the shapes making up composite material sections are accounted for in the LARSA 4D analysis starting with version 8.0.

Composite Construction Section

Sections may be assembled during the construction of a structure. For instance, a steel web may be placed first into a structure, with a concrete slab on top for the deck poured and placed at a different time. While such structures can be modeled with the web and slab as independent elements in the LARSA 4D model, this approach fails to account for the continuity of displacement along the length of the web and slab. Instead, a single section definition containing both the web and slab can be created in the Section Composer. They will, however, be set up so as to be added to the model at separate times.

The differential effects of self-weight, thermal loads, and time-dependent material effects on the shapes making up composite construction sections are accounted for in the LARSA 4D analysis starting with version 8.0.

Index

- add points to shape, 13
- adding shapes, 13
- align, 13
- area, 25
- centroid
 - Creating a Section, 13
 - Overview, 7
 - Section Computations, 25
- centroid offset, 45
- clearance, 25
- Clz, Cly, 25
- composite activity, 61
- composite construction section, 65
- composite construction sections, 61
- composite material section, 65
- composite material sections, 59
- composite section, 7
- composite shape
 - Free Shapes, Cutouts, and Composite Shapes, 27
 - Glossary, 65
 - Overview, 7
- construction sequence section state, 61
- cross-section properties, 25
- custom shape, 13
- cutout shape
 - Free Shapes, Cutouts, and Composite Shapes, 27
 - Glossary, 65
 - Overview, 7
- database, 7
- duplicate section, 13
- duplicate shape, 13
- editing parameters, 13
- export DXF, 13
- export image, 13
- flexural strength, 63
- flip shape, 13
- formula, 7
- formula helper, 51
- formula language, 35
- free draw tool, 27
- free shape, 7
- grid, 13
- import DXF, 13
- import LPSX, 13
- inserting shapes, 13
- integration of Section Composer with LARSA 4D, 13
- introduction, 5
- lpzz, lpyy, lpa, 25
- lzz, lyy, 25
- J
 - Creating a Section, 13
 - Section Computations, 25

- local coordinate system, 65
- lpsx, 7
- member local coordinate system
 - Glossary, 65
 - Member Reference Line and Local Coordinate System, 45
- member reference axes, 7
- member reference coordinate system
 - Glossary, 65
 - Member Reference Line and Local Coordinate System, 45
- member reference line, 65
- merge shapes, 13
- mirror shape, 13
- moment capacity, 63
- moment curvature, 63
- moment of area, 25
- moment of inertia, 25
- moment yield surface, 63
- move shape, 13
- multi-member spans, 51
- nonprismatic section, 65
- nonprismatic variation, 51
- overview, 7
- parameter
 - Glossary, 65
 - Overview, 7
- parameter scope, 35
- parameters, 35
- parametric sections, 35
- parametric shape
 - Creating a Section, 13
 - Glossary, 65
 - Overview, 7
- perimeter, 25
- physical members, 51
- plastic section modulus
 - Creating a Section, 13
 - Section Computations, 25
- principal axes, 25
- Qz, Qy, 25
- radius of gyration, 25
- reference coordinate system, 65
- reference line
 - Glossary, 65
 - Member Reference Line and Local Coordinate System, 45
- reference material, 59
- reinforcement bars, 41
- remove points from shape, 13
- reverse shape point order, 13
- rotate shape, 13
- Rz, Ry, 25
- section
 - Glossary, 65
 - Overview, 7
- section database, 65
- section database (.lpsx file), 27
- section modulus, 25
- section properties, 25
- shape

- Glossary, 65
- Overview, 7
- shape local axes, 13
- shape templates, 35
- shapes, 13
- shift point order in shape, 13
- shift shape, 13
- snap, 13
- spans, 51
- standard shape
 - Creating a Section, 13
 - Glossary, 65
 - Overview, 7
- stress recovery points, 13
- Sz, Sy, 25
- torsion constant
 - Creating a Section, 13
 - Section Computations, 25
- ultimate strength, 63
- units, 13
- weight area, 25
- x variable, 51
- zc, yc, 25
- Zz, Zy, 25